



Attachments and Pre-fabricated Castable Components

**CATALOG/TECHNICAL MANUAL
for Dentists and Dental Technicians**



12th Edition

W o r l d L e a d e r i n D e n t a l A t t a c h m e n t s

CLINICAL WORKSHOP OVERDENTURE ON NATURAL TEETH IMPLANTOLOGY AND CAD CAM



The primary goal of the workshop is to learn the best procedures in planning and developing implant supported bars with detailed focus on conservative and radical prosthesis. Rhein83 wants to support the dentist with innovative working procedures in overdenture and peri-overdenture by analyzing the most modern bar applications and cad-cam procedures.

UNIVERSITY PROGRAMS REMOVABLE PROSTHESIS MASTER COURSES, TRADITION AND INNOVATION OF THE RETENTIVE SYSTEMS



Courses dedicated to universities presenting innovative solutions and procedures in planning the prosthetic projects. Functional, aesthetic and phonetical evaluation of the patient by considering the social conditions and background. Real clinical cases presentation and analysis supported by live working procedures on models with students from universities worldwide. Cultural interchange programs with international universities, post graduate degree programs, international contests and much more!

BASIC LEVEL

Introduction to the Rhein83 techniques in intra-coronal and extra-coronal prosthesis. Innovative procedures allowing to reduce working times and costs by using pre fabricated castable components. Direct overdenture concepts in implantology on all implant brands and platforms.

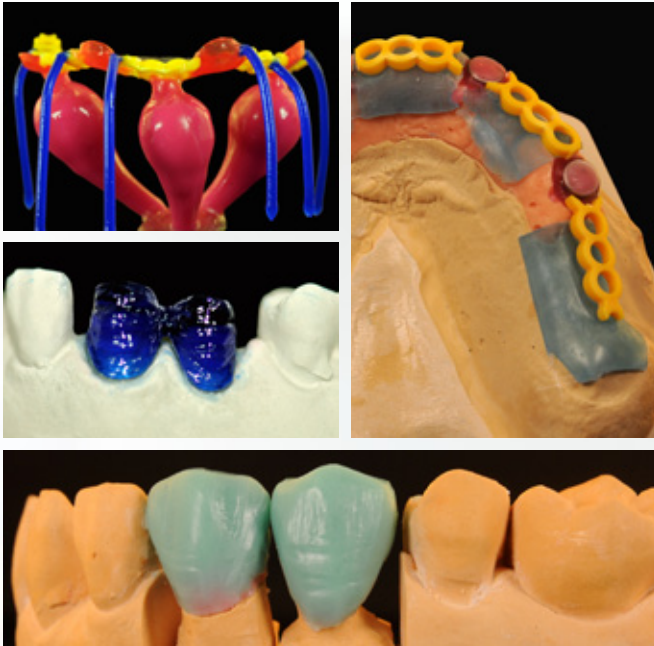

MASTER LEVEL

Deeper insight into the themes presented during the basic course with special focus on implant prosthesis and new digital cad cam working procedures. Simple and useful solutions in complex implantology clinical cases.

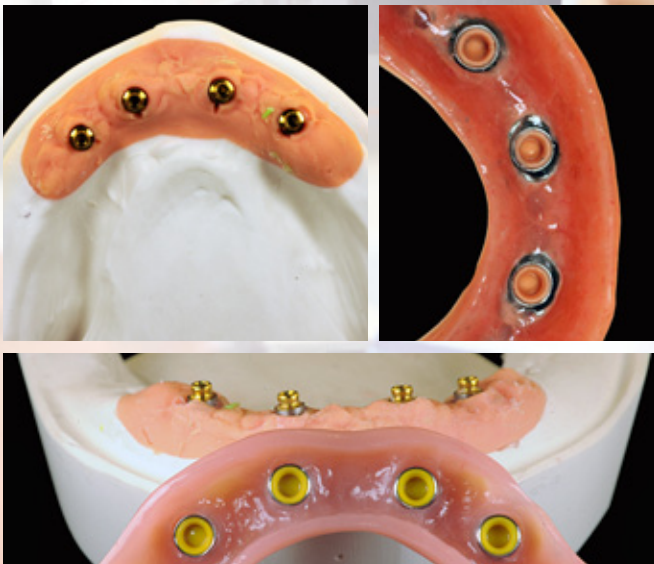

RHEIN83 BIRTH, GROWTH AND EVOLUTION

Metallic spherical attachments exist since many years. But these attachments were not widely accepted, by the dental professionals. Then came the idea to render these mechanisms elastic! A smoothed head and the elastic cap are the result of these innovative changes; today this technique is amongst the most widely used. Rhein83 has been in business since 1983 and today these products have been copied throughout the entire world, copies that in many cases reflect the forms of the objects but not the materials they are made from, and therefore it significantly changes the functional result. Research is not only oriented towards the study of new products, but also continually trying to perfect those that have been used for many years. Dental attachments are small mechanisms subjected to continuous movement, stresses and oral changing, requiring periodic maintenance and revisions. Some products in this have been made for maintaining and restoring the functionality, to all the prostheses, directly while they are in the mouth of the patients. The commitment of Rhein83 with its knowledge and skills continually being enriched by the contributions of dentists and laboratory technicians, is to be able to improve the actual standards and develop new products by means of original projects.

Ezio Nardi

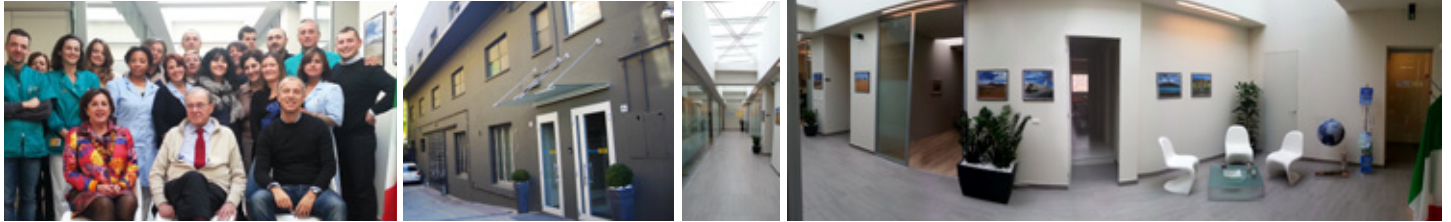

RESEARCH AND INNOVATION TODAY

By over 34 years Rhein83 is continuously innovating the dental attachments world with materials and designs allowing to satisfy the technical requests of the dental specialists.

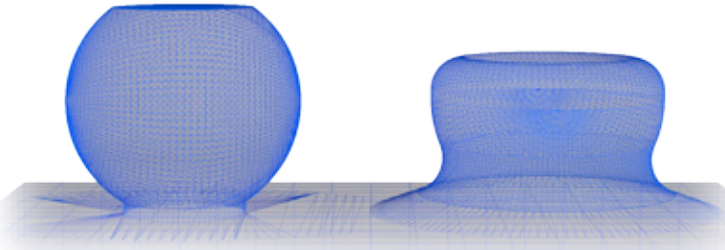

NEW OT EQUATOR PROFILE

Evolution from the sphere to the semi-sphere, reduced dimensions allowing the same stability and functionality!

TECHNICAL INNOVATIONS AVAILABLE TO ALL!



RHEIN83 BIRTH, GROWTH AND EVOLUTION	2
GENERAL INDEX	3
FRICTIONS AND RETENTIONS CONCEPT.....	4
FEMALE CAPS ASSORTMENTS	5
OT EQUATOR CASTABLE	6-7
OT EQUATOR FOR IMPLANTS AND SMARTBOX.....	8-9
OT EQUATOR ELASTIC SEEGER	10-11
OT CAP SINGLE THREADED SPHERES.....	12-13
OT CAP & OT CAP TECNO - COMBINED PROSTHESES	14-15
OT BOX MONO	16
OT STRATEGY - COMBINED PROSTHESES	18-19
OT STRATEGY/STEADY.....	20
OT STRATEGY & OT CAP PROSTHETIC PROJECT	21
SINGLE SPHERES - OT CAP CASTABLE - OT CAP TITANIUM + TiN DIRECT SYSTEM OVERDENTURES	22-23
S.P.L. TITANIUM POSTS FLEX - BLOCK DIRECT SYSTEM OVERDENTURES	24-25
OT BOX, CLASSIC - SPECIAL - CAST REINFORCEMENTS WITHOUT MODEL DUPLICATION	26-27
OT REVERSE 3 DIRECT SYSTEM OVERDENTURES	28-29
RECONSTRUCTIVE SPHERES: CONCAVE SPHERE - OT EQUATOR.....	30
RECONSTRUCTIVE SPHERES: SOLID SPHERE.....	31
OT BAR MULTIUSE.....	32-33
OT VERTICAL	34-35
OT UNILATERAL	36-37
OT LOCK LOCKING PIN	38-39
IMPLANT OVERDENTURE ATTACHMENTS: SPHERO FLEX - BLOCK, DIRECTIONAL RINGS	40-41
IMPLANT OVERDENTURE ATTACHMENTS: UNIVERSAL "ANTI-UNSCREWING" SYSTEMS.....	42
MINI PARALLELOMETER DEVICE WITH MODEL HOLDER BASE AND CUFF HEIGHT MEASURER.....	43
IMPLANTOLOGY: BROKEN SCREW EXTRACTOR FOR IMPLANTS FOR REMOVAL OF BROKEN IMPLANT SCREWS	44-45
INSTRUCTION AND TECHNICAL ADVICE.....	46
ACRYLIC DEMONSTRATION MODELS	47
PRODUCT SPECIFICATIONS.....	48-49-50
KITS AND CODES	51-52-53-54-55
RHEIN83 WORLD WIDE.....	56
SOCIAL MEDIA AND PUBLICATIONS	57

COMPARISON OF RIGID CAPS vs. ELASTIC CAPS

Characteristics and retentive functionality

FRICITION FIT CAPS:
RIGID MATERIALS
 • ACETALIC PLASTICS
 • METALS
 (thin layer)

Friction fit contact zone is very thin because of non-elastic material

FRICITION CONTACT ZONE

With rigid materials, only minimal friction retention is achieved due to the smaller friction contact zone

FLEXION OF THE WALL

With rigid materials, there is an "outward flex" of the wall of the cap

RIGID RESILIENCE

In spite of the flat surface of the sphere, rigid materials do not allow vertical resiliency

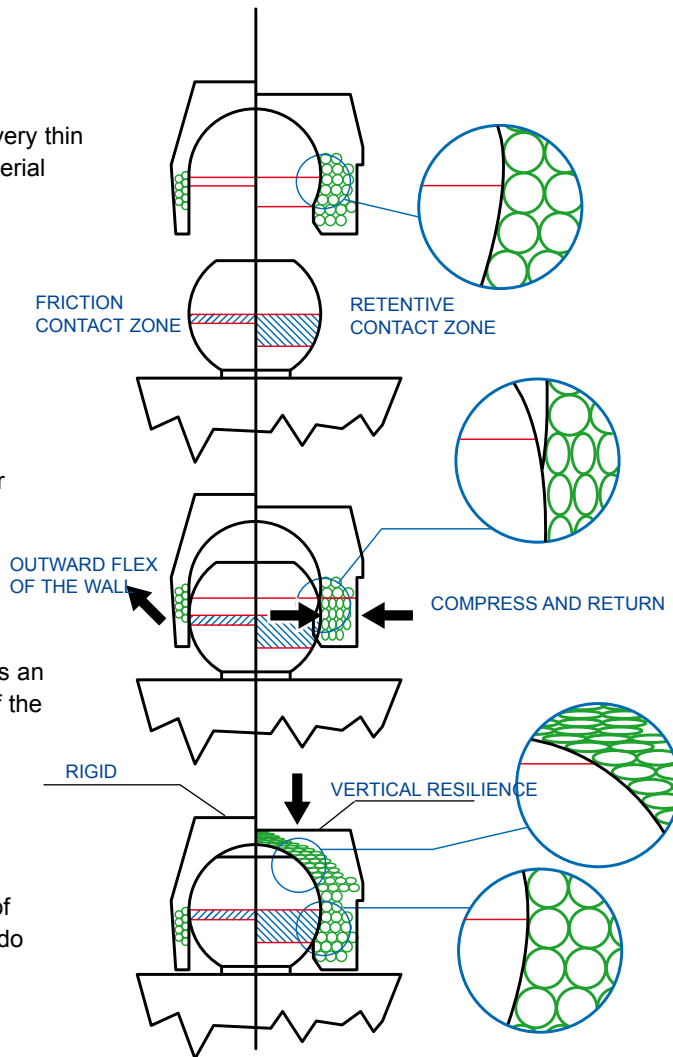

RETENTIVE FIT CAPS:
ELASTIC MATERIALS
 • NYLON
 (thick layer)

The elastic materials allow a wide contact zone of retention by the equator on the undercuts of the sphere

RETENTIVE CONTACT ZONE

With elastic materials, greater friction and mechanical retention is achieved with a higher degree of functionality

COMPRESS AND RETURN

With elastic materials, the wall of the cap is compressed and then returns to its original shape

VERTICAL RESILIENCY

The space between the flat surface of the sphere and elastic cap allows for vertical resiliency and reduces stress

RHEIN83 - DESIGN AND FUNCTION

Rhein83 continues to manufacture female caps with elastic retention with the intention of eliminating as much vertical stress and trauma to the restoration as possible. For Rhein83 the important thing is to make a system of components available to the dental technician and dentist that will allow for the fabrication of a rigid, shock absorbing or resilient prosthesis. With the use of elastic retention, the function of Rhein83 attachments are extended.

With overdenture prosthetic devices or cases involving edentulous saddles, resiliency can be controlled with a wide range of retentive caps that have various levels of elasticity and retention.

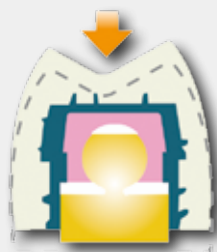

Vertical movement

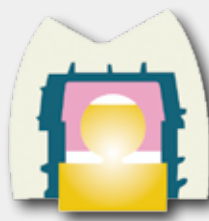

Rigid retention

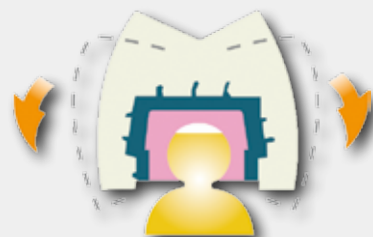

Movement in all directions

CLASSIC CAPS SIZES AVAILABLE: NORMAL AND MICRO

Retentive cap colors and retention

CLEAR CAPS STANDARD RETENTION		Slightly Elastic Maximum suggested time of duration in mouth: 12 months Retention in grams: Normal 1300g / Micro 1100g
PINK CAPS SOFT RETENTION		Elastic Maximum suggested time of duration in mouth: 12 months Retention in grams: Normal from 900g / Micro 800g
YELLOW CAPS EXTRA SOFT RETENTION		Very elastic Maximum suggested time of duration in mouth: 12 months Retention in grams: Normal 500g / Micro 450g
GREEN CAPS ELASTIC AND GUMMY		Characteristics Extremely elastic retention, "GUMMY" type. Minimally hydroscopic, with a good adhesion on the sphere. Retention in grams: Normal 350g / Micro 200g
EXTRA RESILIENT GOLD CAPS SLIGHTLY ELASTIC		Characteristics To be used in overdenture prostheses, where resilience and vertical movements are necessary. Retention in grams: Normal 500g / Micro 450g
EXTRA RESILIENT SILVER CAPS ELASTIC AND GUMMY		Characteristics To be used in overdenture prostheses, where a vertical movement is necessary and a light initial retention is requested. Retention in grams: Normal 350g / Micro 200g
PROCESSING CAPS		Characteristics Caps to be used only for laboratory processing.
TITAN CAPS NYLON CAPS WITH INTERNAL TITANIUM RING		Characteristics Extremely durable. To be used especially in combination with pre-fabricated spheres such as titanium spheres, concave spheres, etc. Retention in grams: Normal 1500g / Micro 1300g
UNDERSIZED INTERNAL DIAMETER CAPS STANDARD RETENTION		Characteristics Internal diameter reduced (Normal 2.2mm Micro 1.6mm), for 2.25mm - 1.6 spheres Retention in grams: Normal 1300g / Micro 1100g
UNDERSIZED INTERNAL DIAMETER CAPS SOFT RETENTION		Characteristics Internal diameter reduced (Normal 2.2mm), for 2.25mm spheres Retention in grams: Normal 900g
UNDERSIZED INTERNAL DIAMETER CAPS EXTRA SOFT RETENTION		Characteristics Internal diameter reduced (Normal 2.2mm), for 2.25mm spheres Retention in grams: Normal 500g
UNDERSIZED INTERNAL DIAMETER CAPS ELASTIC AND GUMMY		Characteristics Internal diameter reduced (Normal 2.2mm Micro 1.6mm), for 2.25mm - 1.6 spheres Retention in grams: Normal 350g / Micro 200g

STAINLESS STEEL AND TITANIUM HOUSING FOR CAPS, PRE-FABRICATED, NORMAL AND MICRO SIZES

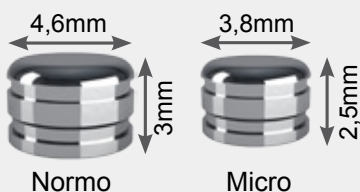

The new stainless steel housing design offer reduced size and additional stability, it can be embodied directly in the resin, welded or bonded to the frame. The new design is also available in titanium.

EXTRA RESILIENCY FUNCTIONALITY

Extra resilient caps, normo and micro size, will allow to absorb elevate masticatory forces without creating any damage to the implant or root.

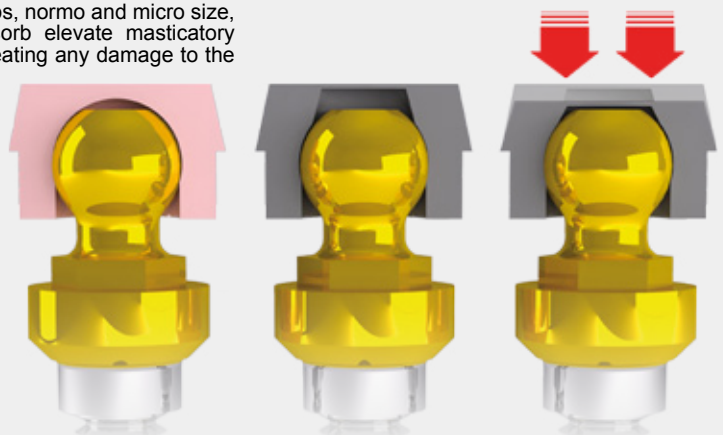

OT EQUATOR CASTABLE

Single Attachment for Overdentures



CLINIC

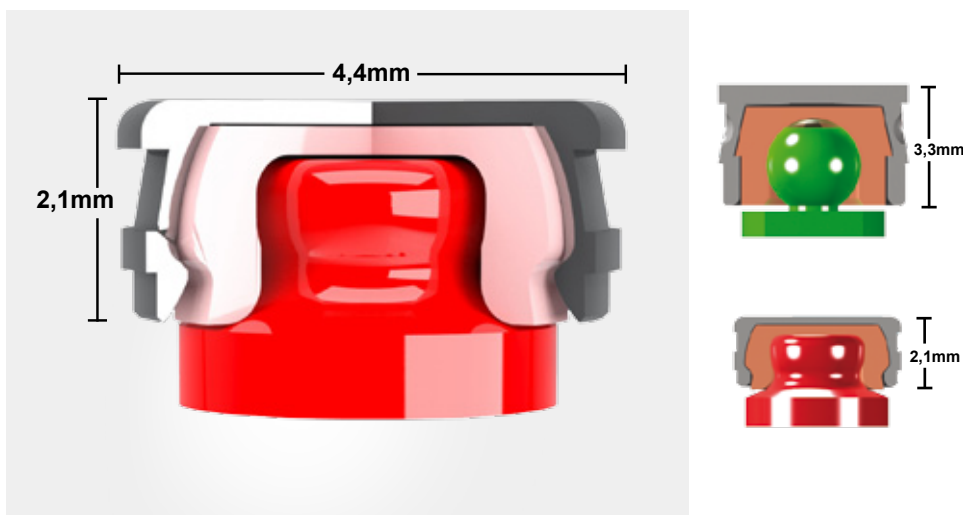

SEVERE DIVERGENCY MAY REQUIRE THE OT EQUATOR IN COMBINATION WITH A CASTABLE UCLA

If additional retention is needed to secure the prosthesis, OT Cap Normal retentive caps and metal housings can be placed over any OT Equator Profile spheres. The prosthesis will be retained in the same way and the connection will be more rigid. Only the dimension of the attachment will be changed.

LABORATORY

OT EQUATOR CASTABLE = INDIRECT TECHNIQUE

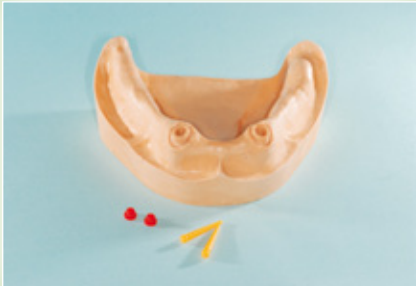

Use separating material on the stone model in the prepared areas to receive the castable posts.



Use longer castable posts in the root channels for easy removal. Reline with castable resin, for higher accuracy.



Place posts and finish margins with composite material. Once resin is cured, cut posts to the required length at root level.



Position OT Equator on the occlusal surface with the paralleling key and continue waxing technique.



OT Equator in the final position. The wax-up has been completed.



For the best results, create the casting with an alloy that has a vickers hardness of 220 or greater.

BUILD UP THE FRAME DIRECTLY ON MASTER MODEL



The plaster model with the OT Equator analog in position. The stainless steel housing and black processing cap are also visible.

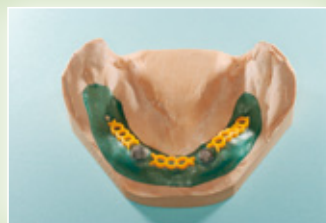

Apply a thin layer (.5mm) of wax to the model. Fill the undercuts on the stainless steel housing and attach the connectors.

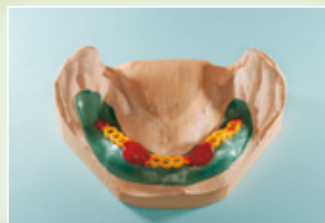

Connect the parts using a castable resin. Be sure to cover the stainless steel housing.

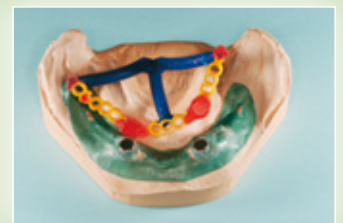

Add sprues to the framework and remove it from the model. Be sure that the stainless steel housing does not remain inside. The framework is now ready to be invested.

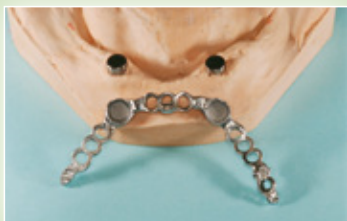

Cast the metal frame and verify the position on the model.



Use composite to bond the stainless steel housing to the frame.



The metal frame with the stainless steel housing in place.



The finished prosthesis on metal frame. After processing, the black caps are replaced with pink caps.

OT EQUATOR FOR IMPLANTS

Low Profile Titanium Abutment

OT EQUATOR

RETENTIVE CAPS OT EQUATOR

- STAINLESS STEEL HOUSING
- TITANIUM HOUSING
- VIOLET CAP RIGID RETENTION (2.7Kg)
- WHITE CAP STANDARD RETENTION (1.8Kg)
- PINK CAP SOFT RETENTION (1.2Kg)
- YELLOW CAP EXTRA-SOFT RETENTION (0.6Kg)
- BLACK CAP PROCESSING

OT EQUATOR TITANIUM + TIN ATTACHMENT

IMPRESSION TRANSFER (pick-up impression)

IMPRESSION TRANSFER (individual tray)

STAINLESS STEEL ANALOG FOR PLASTER MODEL

4,4mm

2,1mm

SQUARE SCREWDRIIVER 1.25mm + OT EQUATOR HOLDER for implant abutment usable with manual wrench torque device

SQUARE DRIVER CONNECTOR 1.25mm for contra angle torque controller

INTERCHANGEABLE OT EQUATOR HOLDER

RATCHET TORQUE CONTROL DEVICE For Sphero block - flex and Ot Equator 15/35Ncm Strength - Max 50Ncm torque, suggested 25Ncm.

OT EQUATOR CAPS INSERTER/EXTRACTOR TOOL for the insertion/removal of the caps into/from the metal housing

The unique design and exceptionally low 2.1mm profile of the OT Equator 4 in 1 System provides exceptional stability and superior retention when compared with other attachment systems. Due to its lower radius, OT Equator is indicated to correct divergence up to 25 degrees between implants without affecting the functionality of the elastic nylon cap. Caps are available in a wide variety of retention levels. ATTENTION; Where implant divergence exceed the maximum 25 degrees, Sphero Block and Sphero Flex are recommended case plan options. See Sphero Block and Sphero Flex page 40-41

Smart BOX

the **self-aligning** Ot Equator Housing

Metal to metal rotational core

Titanium anodized housing

Titanium liner

Elastic cap

25°

new TITANIUM HOUSING WITH BLACK CAP

new SMARTBOX BLACK POSITIONING CAP

Passive insertion reduces trauma

Correct divergency up to 50°

CLINIC

ATTACHING THE CAPS IN CLINIC

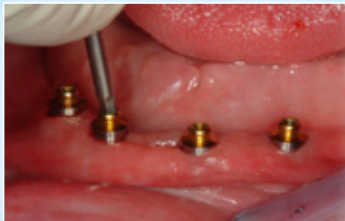

Select the OT Equator with the appropriate cuff height. Screw the OT Equator into the implant.



Place the protective disk over the OT Equator. Then, place the stainless steel housing with cap on the attachment.



Verify the positioning of the prosthesis before bonding the stainless steel housing.

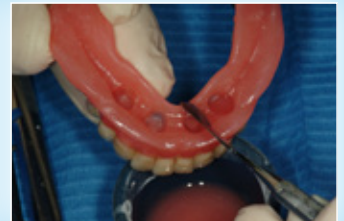

On the prosthesis, fill the implant sites with a self curing resin and insert into the patient's mouth.



Remove the prosthesis and verify that the positions of the attachments are correct.



Remove the protective disks.



Carefully trim away the excess resin.



The completed prosthesis.

IMPRESSION TRANSFER



Place the impression coping on the OT Equator.

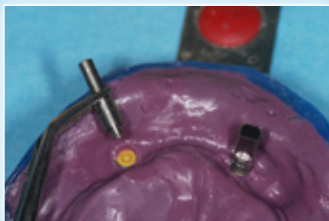

Insert the analog into the impression coping and pour the master model.

LABORATORY

BUILD UP THE FRAME DIRECTLY
(for the full technique go to page 7)

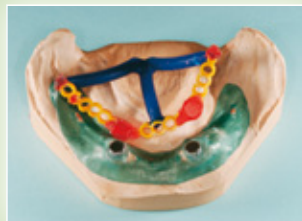

Add sprues to the framework and remove it from the model. Be sure that the stainless steel housing does not remain inside.



The metal frame with stainless steel housings bonded in place.

CLINIC

CHAIRSIDE PROCEDURE FOR SMARTBOX POSITIONING



Select the OT Equator with the appropriate cuff height. Screw the OT Equator into the implant.

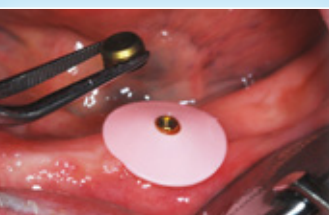

Position the protective disk over the OT Equator.



Fully engage SMARTBOX with Black cap securely onto OT Equator.



Fill the space corresponding to the housings with self curing resin. Insert the prosthesis into the final position.



Once the resin has cured, remove the protective disk.

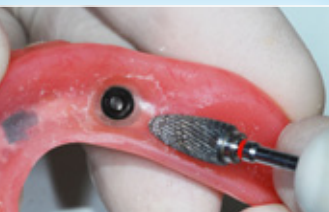

Remove excess resin with bur and polish for passive connection.

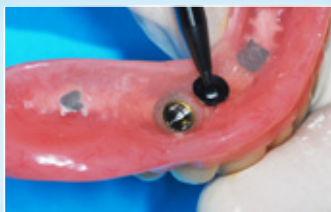

Remove SMARTBOX black cap with cap extractor tool.



Using the cap insertion tool, select 1 of 4 Ot Equator femal caps for desired retention.

ELASTIC SEEGER

Passive bar connection

OT EQUATOR

New SEEGER

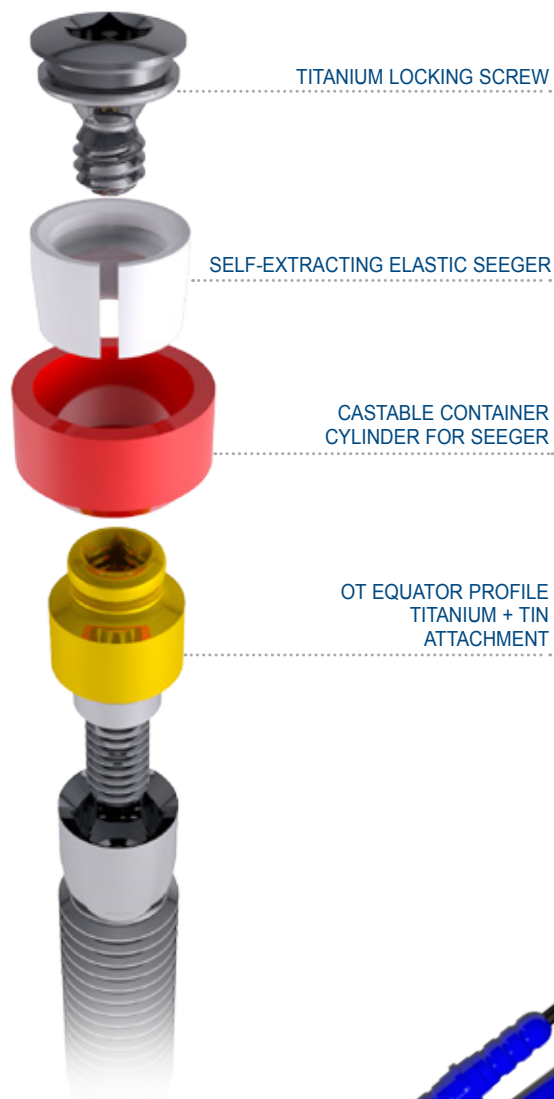

new

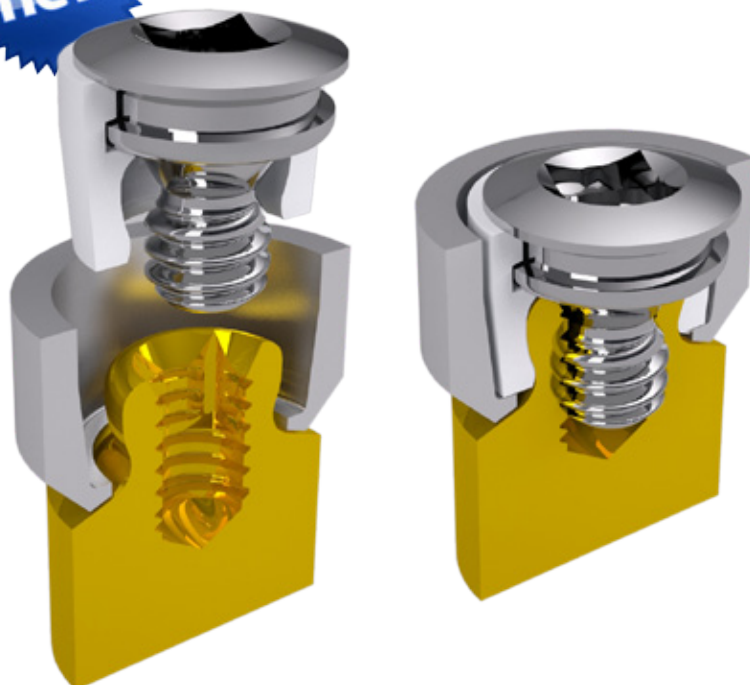

The purpose of the OT Equator “seeger” system is to create a passive connection for implant supported bars. The elastic seeger will correct small imperfections created by the chairside impression technique or laboratory casting process. This reduces the risk of the implant bar to not seat passively.

CLINIC

POSITIONING SYSTEM WITH BAR "ELASTIC SEEGER"



OT Equator titanium attachments screwed into the implants. The elastic seeger system will be used to position the bar.

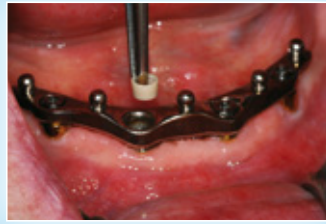

The cast bar in position. Insert the PEEK elastic seeger ring into the cylindrical space.



Using the insertion tool, push down the PEEK elastic seeger ring until it is fully seated.



PEEK seeger ring in position, ready to screw the titanium locking screw.



After the elastic seeger ring has been inserted, lock the bar into place using the titanium locking screw, (Torque suggested 15 Ncm)



The finished bar secured in the mouth. A passive connection has been achieved due to the elastic PEEK seeger rings.



The completed prosthesis. For best results a reinforced superstructure is always recommended.



In case of a future check, the special internal design of the PEEK seeger ring allow the self extraction together with the titanium locking screw

LABORATORY

WAX-UP OF THE BAR DIRECTLY ON MODEL MASTER



Screw the OT Equator attachments into the implant analogs.



Position the seeger castable cylinders, followed by the red plastic seeger for laboratory use on the attachments (Thinner part lower). Screw the titanium sealing lid into position. Do not overtighten.



OT EQUATOR castable attachments are placed on the connecting bar creating a "balance" with the removable prosthesis. Alloys with a Vickers Hardness of 240 or greater are recommended for casting.



Connect the castable abutments with wax or resin.



The cast bar in position on the model.

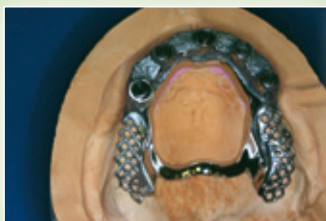

The cast framework in position. Undercuts on the stainless steel housing can be blocked out using composite material to maintain a passive connection.



Fit and stability of the prosthesis can be regulated using nylon caps. Various levels of retention are available.



The final prosthesis.

INTERCHANGEABLE THREADED ATTACHMENTS

with threaded sleeve system

OT CAP

NORMAL SPHERE
HEX 1.3 mm

MICRO SPHERE
HEX 0.9 mm

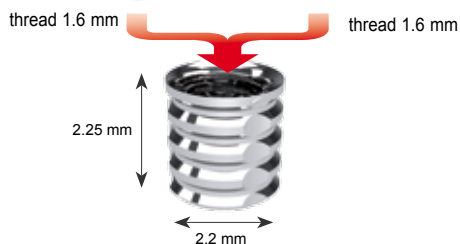

THREADED SLEEVE FOR BONDING



OT CAP SLEEVE SPACERS
Normal/Micro



HEX SCREWDRIVER
HEX 0.9 mm



HEX SCREWDRIVER
HEX 1.3 mm

RETENTIVE CAPS
OT CAP



Clear Standard, Pink Soft, Yellow Extra Soft, Green Elastic, Black Processing



S. STEEL HOUSING
OT CAP NORMAL / MICRO

TITANIUM HOUSING
OT CAP NORMAL / MICRO

OT EQUATOR

OT EQUATOR
SQUARE HEAD

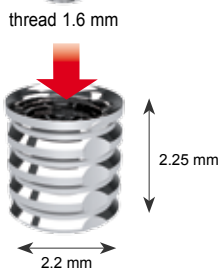

THREADED SLEEVE FOR BONDING



SCREWDRIVER
OT EQUATOR SQUARE HEAD + INTERCHANGEABLE HOLDER



S. STEEL OR TITANIUM HOUSINGS
OT EQUATOR



OT EQUATOR SLEEVE SPACER

RETENTIVE CAPS
OT EQUATOR



Violet Strong, Clear Standard, Pink Soft, Yellow Extra Soft, Black Processing

PARALLELOMETER
MANDREL Normal / Micro



OT EQUATOR CAPS
INSERTER/EXTRACTOR TOOL
for the insertion/removal of the caps
into/from the metal housing



OT CEM COMPOSITE MATERIAL
Metal to Metal Bonding

OT CAP - OT EQUATOR FOR CAD-CAM MILLED BARS

NORMAL SPHERE



Standard
2 mm Thread

MICRO SPHERE



Standard
2 mm Thread

OT EQUATOR



Standard
2 mm Thread

LABORATORY



OT EQUATOR

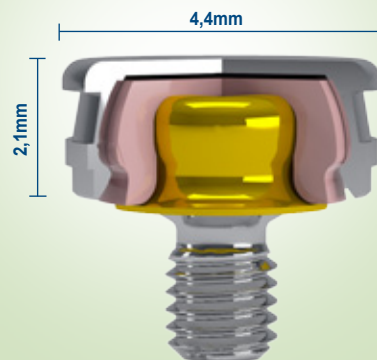

STEP BY STEP THREADED SLEEVE BONDING PROCEDURE

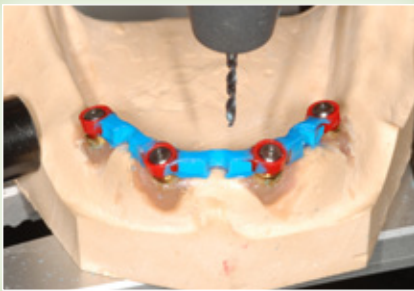

Once the bar has been connected with wax, create an area where the attachment spacer will be placed.



Apply separator to the base of the attachment spacer and position using the parallelometer key.



With the attachment spacer in position, complete the wax-up design.



Carefully remove the attachment spacers and proceed with the normal casting procedure.

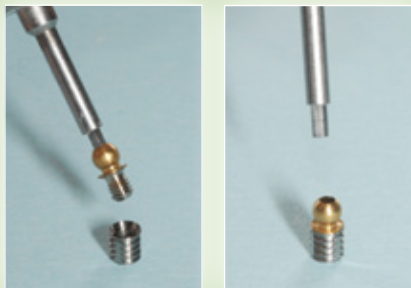

Screw the threaded attachment of choice (Micro Ball shown) into the threaded sleeve.



Place the assembled attachment into the parallelometer key. Use a self curing metal to metal bonding composite on the sleeve and in the cylinder.



After the composite is cured, remove any excess material.



Unscrew the attachment to verify if the threaded sleeve is securely bonded in place.



The finished bar complete with attachments.

3 ATTACHMENT OPTIONS

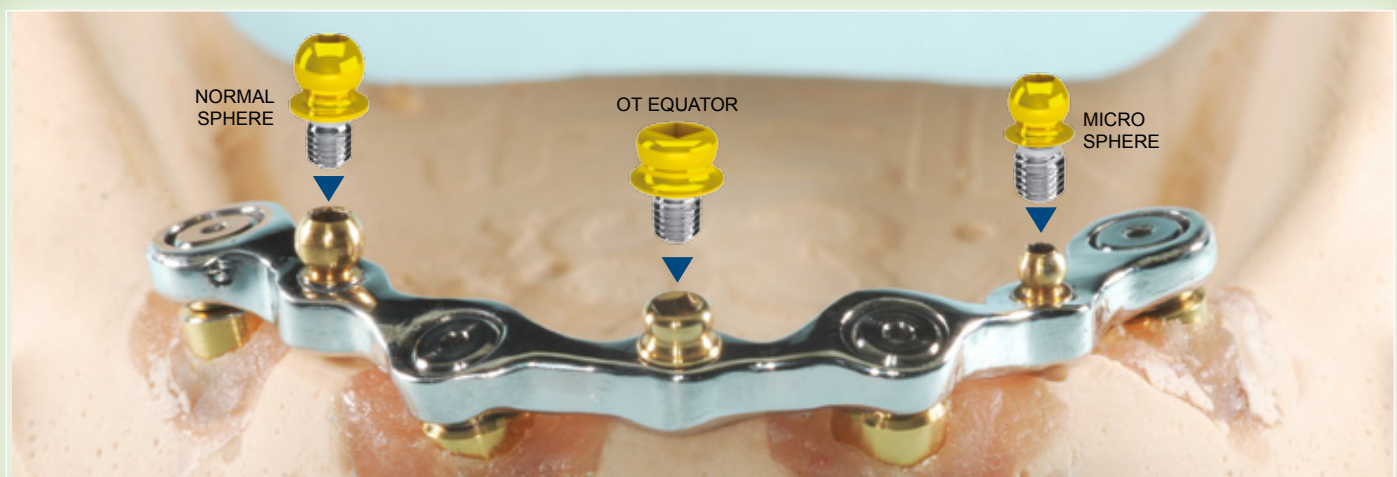

THE TECHNIQUE IS THE SAME FOR ALL THREE OPTIONS

EXTRACORONAL CASTABLE ATTACHMENTS

OT CAP - OT CAP TECNO



STAINLESS STEEL
AND TITANIUM HOUSINGS
Normal / Micro
for curing, welding or bonding



OT BOX MONO
Normal / Micro



RETENTIVE CAPS
Normal / Micro



TITAN CAP
Normal / Micro



CASTABLE BARS
Normal / Micro

PARALLELOMETER
MANDREL FOR OT CAP
Normal / Micro



REGULATING TOOL FOR
RETENTION
Normal / Micro



PARALLELOMETER
MANDREL
FOR OT CAP TECNO
Normal and Micro



OT EQUATOR CAPS
INSERTER/EXTRACTOR TOOL
for the insertion/removal of the caps
into/from the metal housing



LABORATORY



OT CAP TECNO

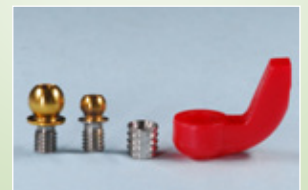

View of the Ot Techno system, Normo or Micro sphere can be used with the same threaded sleeve.

OT MONO BOX



OT BOX MONO: The positioning ring to be inserted on the sphere before model duplication.

OT Cap is a resilient distal extension attachment. It is indicated to be used with combined prostheses and removable partial dentures.

For treatment plans that require a rigid substructure with milling and adequate counter attachments, OT Cap functions as a stabilizing retentive connector. In addition, for treatment plans which require resiliency, OT Cap provides a "Cushion Effect" similar to a shock absorber. This is achieved by the design of the sphere in conjunction with the elastic retentive caps.

The OT Cap Tecno consists of a titanium sphere and ring that is incorporated into the nylon cap which has been machined with a tolerance that assures high precision. While fabricating the prosthesis, the Tecno titanium sphere is not exposed to any of the risks associated with the laboratory fabrication procedures and ceramic firing cycles.

COMBINED PROSTHESES

with extracoronal castable attachments

CLINIC



OT CAP CASTABLE



Cut the plastic bar and use only the section that you need.



Using the mandrel, position the spheres in parallel. Complete the wax-up with a "ledge" along the crown. The "ledge" must not be lower than the sphere.



The cast crowns. It is suggested to use a retentive cap to protect the sphere from any damage.



The cast attachment. The "ledge" along the crown helps select and redirect the vertical loads.



Using the mandrel, position the Ot Tecno castable extension in parallel. Complete the wax-up with a "ledge" along the crown and cast.



Place the assembled attachment into the parallelometer key. Use a self curing metal to metal bonding composite on the sleeve and in the cylinder.



After the composite is cured, remove any excess material.



Unscrew the attachment to verify the threaded sleeve is securely bonded in place.

CAST HOUSING WITH DUPLICATED MODELS



The OT Cap positioning ring on the sphere.



The duplicated model in investment.



The OT Mono Box castable housing in position and incorporated into the final wax design.



The final OT Mono Box casting with retentive caps inserted into the housing.

The castable **OT MONO BOX** reproduces the shape of the housing which incorporates the retentive cap into the framework. Use the OT CAP insertion tool to place the retentive cap into the housing.

CASTABLE HOUSING

Customized solution for frames with single castable sphere housing for caps



CASTABLE HOUSING

SINGLE HOUSING
Castable Normal size



POSITIONING RING

SINGLE HOUSING
Castable Micro size



POSITIONING RING

HOUSINGS:

STAINLESS STEEL - TITANIUM

The new stainless steel housing design offer reduced size and additional stability, it can be embodied directly in the resin, welded or bonded to the frame.

The new design is also available in titanium.

SIZE FOR RESIN OR SOLDERING

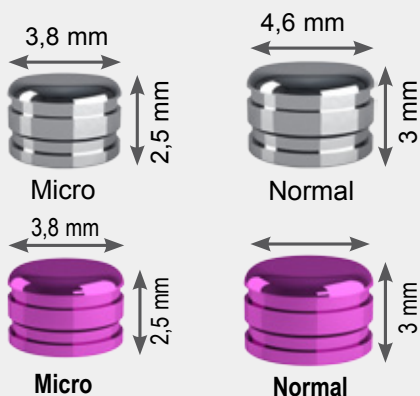

LABORATORY

When vertical space is limited, use reinforced pins to reduce the risk of breakage of the denture teeth.

SOLUTION A



Place a piece of .5mm calibrated wax over the wax-up design for additional protection.

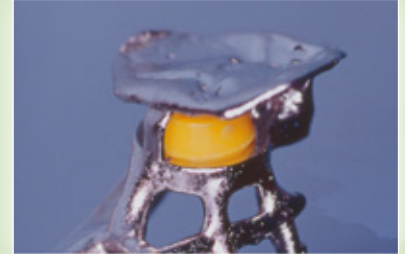

The finished casting with retentive cap in place.

SOLUTION B



Small wax pins are added for reinforcement of the denture acrylic as well as additional retention for the denture teeth.



The final cast housing with reinforced metal pins.

STAINLESS STEEL PRE-FABRICATED HOUSINGS

For bonding or soldering to the frame

To obtain the right position use the POSITIONING RINGS.

NORMAL and MICRO sizes are available.



Rhein83 continues to be the world leader in spherical attachments and implant components. Largely due to continuous research and development, active participation in exhibitions as well as providing practical hands-on technical training for dentists and dental laboratory technicians. In addition, the company utilizes state of the art technology to constantly develop new products and improve existing product design as well as promote product awareness.

Rhein83 attachment systems are technically supported in over 75 countries worldwide.



Ezio Nardi Founder Claudia Nardi President Gianni Storni VP Technology



CERTIFICATIONS:

Since 1996 Rhein83 has been operating with a quality control system that conforms to:

UNI EN ISO 9001:2008 Standards

UNI CEI EN ISO 13485:2012 Standards

Directive 93/42/EEC

Rhein83 received this certification from Clementi, Italy, which is the certifying body for all activities associated with C€ certification.

That same year, the company passed the rigorous requirements for the United States Food and Drug Administration, permitting it to sell attachments and implant components in the United States market.

All of the components are designed, manufactured and sold with respect to the D.Lgs 37/10.

CASTABLE VERTICAL ATTACHMENT MICRO



FOR DUPLICATION TECHNIQUE

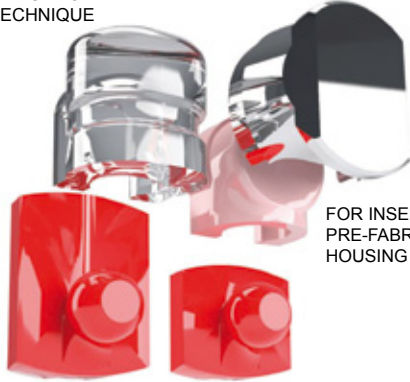

FOR INSERTION INTO THE PRE-FABRICATED HOUSING

CAPS



Clear • Standard



Pink • Soft



Yellow • Extra Soft



Black • Processing

STANDARD BASE

Sphere Ø 1.8 mm
LONG BASE
Sphere Ø 1.8 mm



ANALOG POST

CAPS

Clear • Standard



Pink • Soft



Yellow • Extra Soft



Black • Processing



OT STRATEGY CAPS INSERTER/EXTRACTOR TOOL



PARALLELOMETER MANDREL



STAINLESS STEEL HOUSING to be welded or bonded to the frame



STRATEGY POSITIONER for correct positioning of the cap housing on the frame

PARALLELOMETER KEY PROFILE



SIDE A: For SPHERE positioning
SIDE B: For STEADY positioning

REINFORCEMENT FOR THE SPHERE



- Increased shear force strength
- Prevents rotation of female cap
- Increased lateral stability

OT Strategy from Rhein83 is a vertical micro-sized 1.8 mm castable sphere that is placed distally on abutments for removable partials or utilized in implant bar combination case design. The male component is designed with an additional support strut located under the sphere, increasing strength and preventing rotation of the female cap during paralleling. The optional Steady, when connected to OT Strategy, provides lateral stability without any additional milling.

OT Strategy caps are available for both duplication and fabrication using a stainless-steel housing technique. Rhein83 caps are manufactured from an elastic material that increases the contact zone with the sphere, giving mechanical and friction retention. Caps are color-coded indicating five levels of retention. Tools for paralleling, inserting, and removing caps are available.

CLINIC



LABORATORY



Insert the OT Strategy male into the mandrel and place in position with base of attachment in contact with the stone.



The entire cap must be covered with a thin layer of wax during the frame wax-up procedure.

Once the casting is complete, proceed to use the cap and the prefabricated **STAINLESS STEEL HOUSING**. The housing can be bonded or laser welded to the frame. In addition, it can also be used for direct chairside procedures.

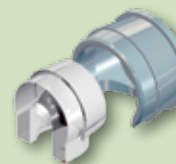

For best results during the **DUPLICATION TECHNIQUE**, it is suggested to use the **YELLOW** retentive cap.





DUPLICATION TECHNIQUE: USING CASTABLE HOUSING



OT Strategy casting is complete with mandatory lingual milling to accept partial bracing arm.



Yellow retentive cap is placed on the sphere and the model is ready for duplication. Use wax to remove any undercuts.



Model is duplicated and the shape of the cap is reproduced.

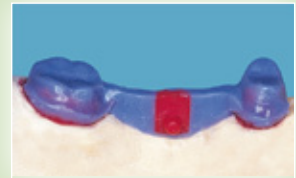

Insert the black cap into the skeletal cast frame cast partial with the OT Strategy Insertion Tool.



Frame is complete and placed on the model.

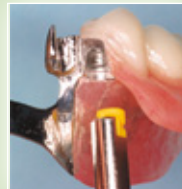

Using the insertion tool, insert the cap.



The finished prosthesis.

WELDING TECHNIQUE: USING PRE-FABRICATED STAINLESS STEEL HOUSING

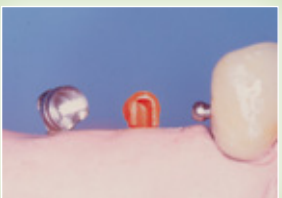

Crown and OT Strategy attachment cast. Positioning ring and housing.



Positioning ring on the sphere.



Stainless Steel Housing in position on the attachment.

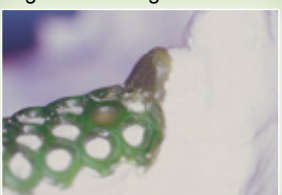

Wax-up on the duplicated model.



First Option: Stainless Steel Housing welded to the frame.



Second Option: Stainless Steel Housing bonded to frame with anaerobic self-curing resin.



ATTENTION:
Insertion of the cap from the mesial.

CASTABLE VERTICAL MICRO ATTACHMENT STRATEGY + OPTIONAL STEADY



CLINIC



LABORATORY

TECHNIQUE WITH STANDARD BASE



Lute the two parts together using an adhesive and insert the sphere into the mandrel of the parallelometer.

The Steady can be used with its original height or it can be shortened and modified to accommodate the adjacent tooth and ridge.

Finish the wax-up and give the Steady the necessary shape for duplication in the sphere.



The duplicated model.

The frame wax-up.

The finished casting.

TECHNIQUE WITH LONG BASE



Lute the Steady to the Long base. Be sure to position the two parts according to the resorption of the ridge.

Position the attachment as close to the ridge as possible. Fill the space between the Steady and the ridge with wax.

The finished attachment design. The Steady has been adapted to the contour of the ridge.



Crown and Steady for duplication and retentive cap on the sphere.

Cast framework seated on the model.

Finished prosthesis.

When the **STEADY** base is utilized it provides superior lateral support when milling is not indicated. In the case of free saddles, the **STEADY** base avoids movement in all directions during mastication.

Optional = STEADY

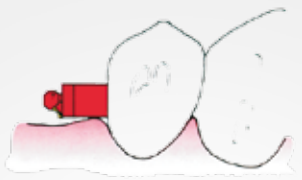

Steady + standard base

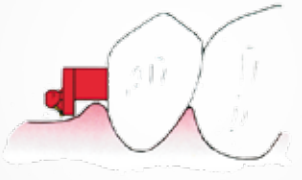

Steady + long base

The castable Steady is an optional conical shaped support intended for use in cases where milling is not performed. Steady can be used with the OT Strategy Standard or Long base.

It is an object in line with the philosophy of the personalization of each single prosthesis and is used with both the OT Strategy bases; Standard or Long and offer various technical solutions.

CLINIC

LABORATORY

OT STRATEGY

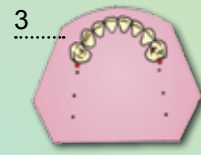
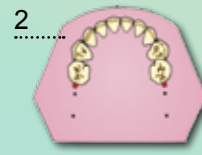
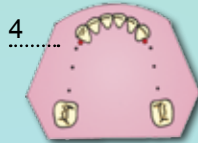

OT CAP



OT CAP LOWER ARCH

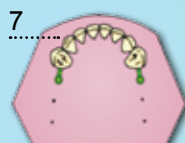

OT CAP UPPER ARCH

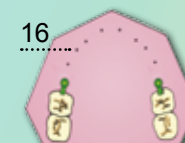
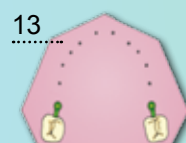

SINGLE SPHERES OT CAP



STAINLESS STEEL AND TITANIUM HOUSINGS
Normal / Micro size for curing welding or bonding



SINGLE SPHERES
TITANIUM + TIN
1600 Vickers Hard
FOR WELDING
OR BONDING

CASTABLE
SINGLE
SPHERES



NORMAL
Green
Ø 2.5 mm



MICRO
Red
Ø 1.8 mm

ELASTIC RETENTIVE CAPS
Normal / Micro



Clear • Standard



Pink • Soft



Yellow • Extra Soft



Green • Elastic



Black • Processing

Undersized caps for worn or damaged spheres are also available. They are also compatible with 1.7mm and 2.2mm spheres. See parts list for item codes and descriptions.



IMPRESSION
COPING
Normal / Micro



PIVOT ANALOGS
Normal / Micro

PLASTIC PIVOTS
for impression of the root canals



Normal

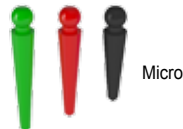

Micro

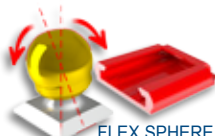

FLEX SPHERE
Ø 2.5 mm

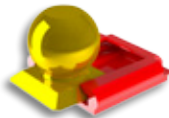

FIXED SPHERE
NORMAL SIZE
Ø 2.5 mm



FIXED SPHERE
MICRO SIZE
Ø 1.8 mm



CASTABLE
SLIDING BASE



PARALLELOMETER
MANDREL
Normal/Micro size



MOESER BURS



PROTECTIVE
DISKS



OT EQUATOR CAPS
INSERTER/EXTRACTOR TOOL
for the insertion/removal of the caps
into/from the metal housing

CLINIC



TRANSFER IMPRESSION TECHNIQUE



Put the impression coping on the sphere in the patient's mouth. Different levels of retention are available depending on the color of the cap used.

Impression coping in position, the external profile ensures a stable position in the impression.



Insert analogs into the impression copings and pour the model.



Stone model with analogs in place.

LABORATORY



ATTENTION:

These attachments can be cast with all types of alloys, but it is important to use a metal with a high Vickers hardness in order to avoid the risk of wearing the spheres.

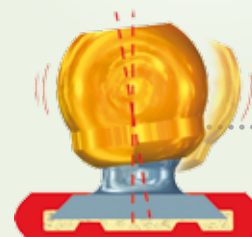
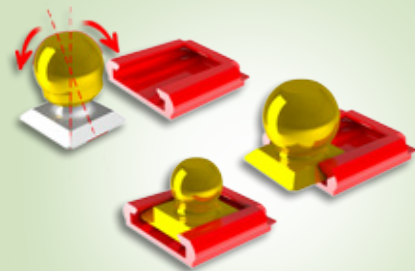

NEW
DESIGN

EASY FIT

The design of the sphere with a FLAT head in addition to the spherical inner surface of the elastic cap, permits vertical movement during mastication. Rhein83 female caps are manufactured out of a special nylon material that remains stable and continues to function in the oral cavity over long periods of time.

Clinical data is available showing that stability is obtained with a minimal amount of trauma.

IMPRESSION OF ROOT CANALS



Prepare the roots.



Apply adhesive to the post.

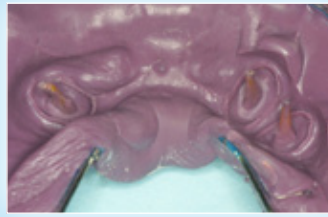

Impression with elastomer.

ATTENTION:

To obtain proper function, it is important to mill the resin with a bur to create a space (highlighted in blue) between the root and the prosthesis.

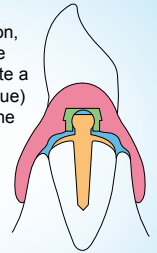

OT CAP - EMBODING STAINLESS STEEL HOUSING TO DENTURE



Protective discs on the cast metal spheres.



Fill the space corresponding to the housings with self curing resin. Insert the prosthesis into the final position.



Once the resin has cured, remove the disc and trim the excess material around the housing.



Finished prosthesis.

OT CAP - CASTABLE SINGLE SPHERE TECHNIQUE



Insert the castable plastic post into the prepared root cavity.



Cut the post to the level of the root and remove the sphere.

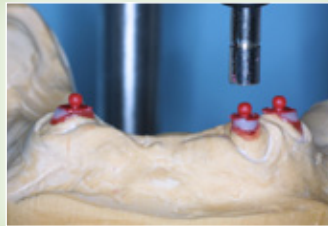

Position the single spheres in parallel with each other.



Cast post and sphere. It is also possible to place the sphere off center in respect to the long axis of the post.

OT CAP - TITANIUM SINGLE SPHERES + TIN FOR CURING WELDING OR BONDING



Wax-up the root cap. Insert the titanium sphere into sliding base and position it on the root cap.



Wax-up with titanium sphere in position. Do not cover the "open" side of the base with wax.



Remove the titanium sphere from the base before attaching sprue.



The finished wax-up with sprue. The root cap and post is ready to be invested.



Using the tool, check the fit of the cast cap by inserting the sphere into the base.

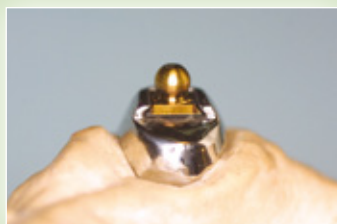

Titanium sphere inserted in the cast root cap base.



Bond the titanium sphere to the base using anaerobic or self curing composite material.



Finished root cap. The sphere is bonded and locked in position.

PIVOTS FOR DIRECT OVERDENTURE



PIVOT FLEX
TITANIUM + TIN
1600 Vickers Hard
"self-parallelizing" sphere



STAINLESS STEEL AND
TITANIUM HOUSINGS
Normal / Micro size curing
welding or bonding



ELASTIC RETENTIVE CAPS
Normal / Micro



SUPER-RESILIENT CAPS

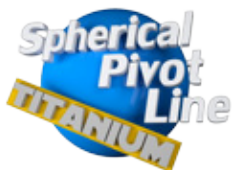

**TITANIUM
PIVOT BLOCK**
(Ø 2,5 mm/Ø 1,8 mm)



**LOW PROFILE
TITANIUM + TIN PIVOT**
(over 1600 Vickers)

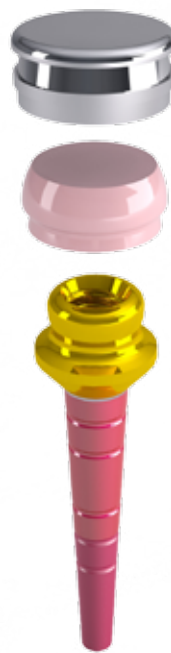

PIVOT FLEX
TITANIUM + TIN
Ø 2.5 mm 3 lengths



PIVOT BLOCK
TITANIUM WITH STATIONARY SPHERE
NORMAL Sphere
Ø 2.5 mm 3 lengths



PIVOT BLOCK
TITANIUM WITH STATIONARY SPHERE
MICRO Sphere
Ø 1.8 mm 3 lengths



OT EQUATOR PIVOT
LOW PROFILE TITANIUM PIVOT
3 lengths: 10,9,7mm



MOOSER BURS



PROTECTIVE DISKS

The Pivot Flex line of titanium posts was developed as an economical solution for direct "in root" supported overdentures. The self-aligning Pivot Flex post features a rotating ball with a 2.5 mm diameter and is indicated for divergent roots. When the posts are used with directional rings to align retentive caps before the resin curing stage, the insertion of the denture is easy and trauma-free. The Pivot Block line of milled titanium posts has a stationary ball and can be used for a temporary or as a permanent solution. The Pivot Block titanium posts are available in 2.5 mm and 1.8 mm sphere diameters. The Rhein83 elastic caps ensure optimal retention and function while minimizing wear. There are five levels of retentive caps, including extra resilient caps for precarious root situations. The levels of retention are identified by different colored caps.

CLINIC

DIRECTIONAL RINGS - FOR FIXED AND ROTATING SPHERES



Pivot Flex posts in divergent roots.



Nylon caps without directional rings. Caps are not supported in the same horizontal plane.



Nylon caps with directional rings. Caps are now supported in the same horizontal plane.

DIRECTIONAL RINGS

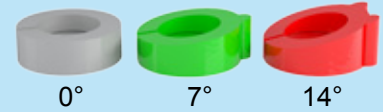

PIVOT BLOCK - FOR TEMPORARY OR PERMANENT ECONOMICAL SOLUTIONS



Pivot Block cemented with oxyphosphate cement for a temporary solution.



To remove the post from the root, grasp the sphere with the pliers and rotate carefully in both directions.



Due to the conical shape and smooth surface, the post is removed easily.

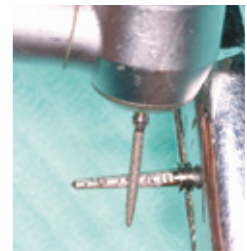

For permanent solutions, create notches in the post and roughen the surface before cementation.

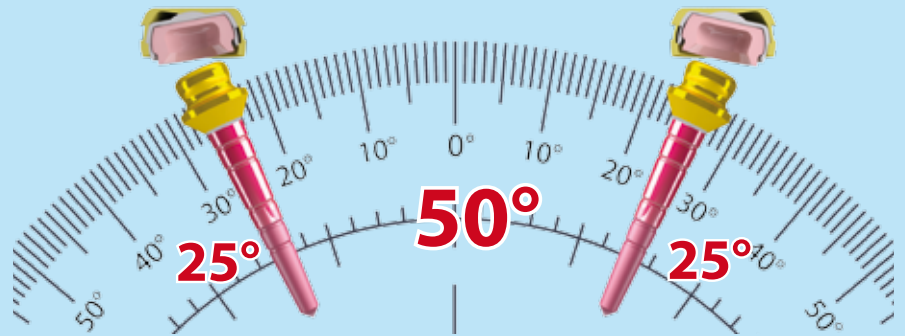

Thanks to the use of the OT Equator Smartbox housing, it's possible to correct divergency up to 50 degrees.

TITANIUM PIVOT BLOCK AND OT EQUATOR: PERMANENT FIXATION IN THE PATIENT'S MOUTH



Prepare the root by the mucosal level and adjust the radicular cavity by using a Mooser Bur with the proper dimensions.



Fill-up the radicular cavities with proper composite cements, insert than the spherical titanium pivots.

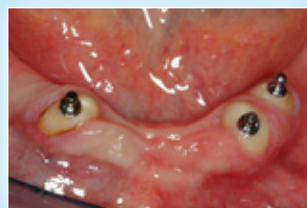

Cemented micro block pivot in position, retentive notches were applied to support the permanents fixation.



Place the directional rings in position between the roots and retentive caps. Proceed by taking the imprint.



Alginate impression: attachment placements in evidence.



Place the protective disks between the directional rings and the retentive caps. Feel with self curing resin and than place the prosthesis in the patient's mouth.



When the resin will be hard enough remove the protective disk and clean up any excess of resin.

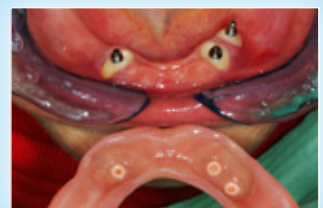

Completed prosthesis.

CASTABLE BAR CAP HOUSINGS

OT Classic BOX + CONNECTOR

OT Special BOX + CONNECTOR



CLASSIC BARS
 NORMAL - Green + Yellow
 MICRO - Red + Yellow



CONNECTOR
 Universal castable bar for joining the OT BOX housings

ELASTIC RETENTIVE CAPS
 Normal / Micro size



EXTRA-RESILIENT CAPS

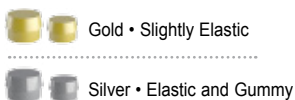

IMPRESSION COPING
 Normal / Micro



SPECIAL BARS
 NORMAL - Green
 MICRO - Red



ANALOGS
 Normal / Micro

CLINIC



Cast reinforcement wax-up on the master model without duplication.

LABORATORY

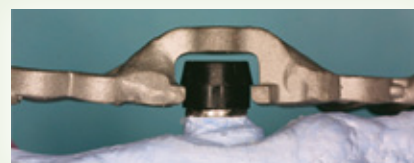

The OT Box Large casting compensates for the distance between the cap and the housing. It is manufactured to reposition the cap chairside into the frame.

OVERSIZED CASTABLE HOUSING for repositioning the caps directly in the patient's mouth



NORMAL + CONNECTOR

MICRO + CONNECTOR



A fracture is more likely to occur where the overdenture attachments are inserted in a prosthesis fabricated entirely of resin. With a cast superstructure reinforcement, the denture will be less likely to fracture. Fast and simple, the OT Box bar components are used to fabricate the superstructure directly on the master model, eliminating duplication and saving time. A non-precious or chrome cobalt alloy is recommended for best results.

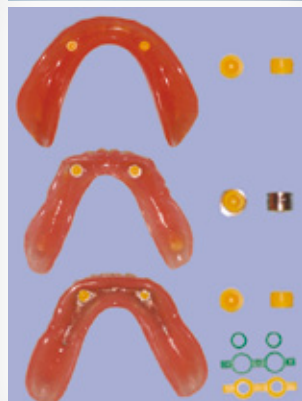

It is recommended that all nylon caps are inserted into a stainless steel housing or cast reinforced frame. The stainless steel housing offers a considerable advantage when the cap has to be removed and replaced for routine maintenance or repositioned. Adjustments or repairs can be performed chairside quickly and easily.

Option 1: OT CAP
 OT Cap cured directly into the prosthesis.

Option 2: OT Cap + Stainless Steel Housing
 OT Cap with housing cured directly into the prosthesis or bonded into frame.

Option 3: OT Cap + OT Box
 OT Cap inserted into OT Box cast reinforced frame.

LABORATORY REQUIREMENTS FOR THE MASTER MODEL

When a new denture is being fabricated utilizing existing spheres, the dentist must provide the laboratory with an impression using the YELLOW CAP. The laboratory will place the analog into the cap and pour the stone model.

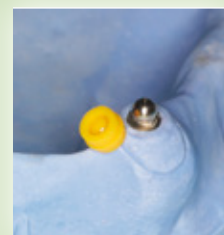
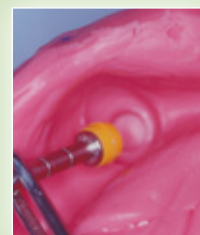

CAST REINFORCEMENT IN ACRYLIC DENTURES

without duplication of the model

IMPRESSION WITH POSTS FIXED IN THE MOUTH



Titanium posts cemented into the root.



Before taking the imprint place the transfer over the spheres supported by the proper directional ring.

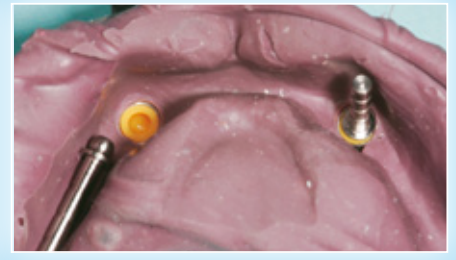

Insert analogs into the impression copings and pour the model.



Stone model with analogs in place.



Plaster model with metal-fused components.



DIRECT WAX-UP ON THE MASTER MODEL



OT Box Classic. Glue the two OT Box bars together.



Separate the housing from the OT Box bar connector.



"ONE-PIECE" MONO BAR

OT BOX SPECIAL is a "one-piece" mono bar. Separate the bar and use only the section needed.

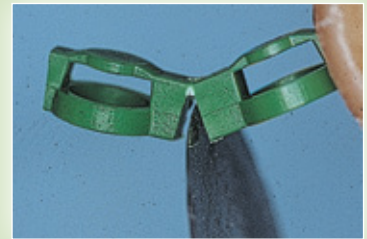

Apply a layer of wax on the ridge. Create three holes in contact with the stone model. Place the positioning rings over the spheres. Be sure to place the ring with the "flared" end towards the coping.



Position the OT Box Classic or Special housings over the rings. Complete the reinforcement using the connectors and join the pieces together with self-polymerising resin.



Finished wax-up with sprue; ready to be invested.



Finished casting with black retentive caps in housing.



Complete prosthesis with cast reinforcement.



For additional reinforcement...with the silicon mask in position, insert a wax pin to support each tooth before casting.



ROOT TITANIUM + TIN ATTACHMENT



STAINLESS STEEL AND TITANIUM HOUSINGS



MALE RETENTIVE
ø 1.8 mm



CONNECTION ROOT PIVOT
TITANIUM + TIN



ABUTMENT TRANSFER COPING



CAPS EXTRACTOR WITH HOUSING FOR INSERTION TOOL

Male insertion tool
OT REVERSE 3



MANUAL TOOL



ANALOG FOR ROOTS



PROTECTIVE DISK



DIAMOND SIZING BUR
For root preparation

CLINIC

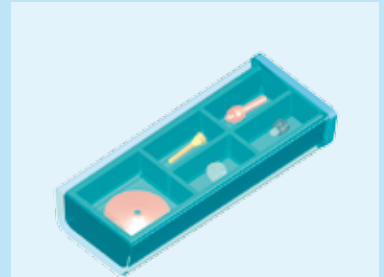

- Ref. 034 PRK - PACK:
 N. 2 Root Pivots in Titanium+TiN
 N. 2 Retentive Males in Titanium + NYLON
 N. 2 Plastic Hand Tools
 N. 2 Stainless Steel Container
 N. 2 Protective Disks

PROSTHESIS WITH REINFORCEMENT IN CAST METAL



POSITIONER FOR DUPLICATION



STAINLESS STEEL AND TITANIUM HOUSINGS



CONNECTORS



ANALOG FOR ROOTS



MANUAL TOOL



ANALOG FOR MODEL



OT BOX LARGE



OT BOX SPECIAL



OT BOX CLASSIC

LABORATORY



OT REVERSE 3 is a root supported direct pivot attachment system which provides retention and stability for full dentures. The "split" male portion of the attachment is manufactured from titanium that is embedded into a soft nylon material. The female pivots have a unique shape that is designed to fit most remaining root structures. OT REVERSE 3 is successful even with minimal bone support of the remaining dentition. The system is cost effective with simple laboratory and chairside procedures.

ROOT PREPARATION AND IMPRESSION

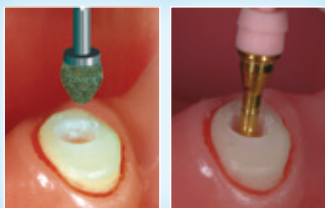

Use the diamond sizing bur to prepare the root for the attachment. Using the hand tool, insert the plastic pivot and apply cement.



Pivots cemented into the roots. Insert the male transfer coping into the pivot and take the impression. For best results, use a stiff bodied impression material.

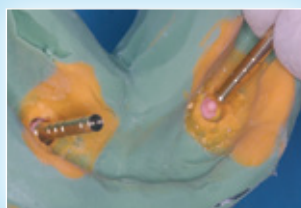

The laboratory will place the analog and pour the stone model.

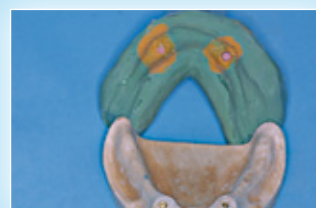

The stone model with the OT REVERSE 3 analog in position.

CHAIRSIDE PROCEDURES

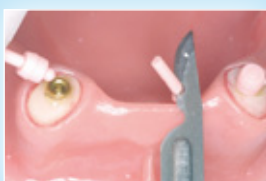

If you are using the plastic retentive male, remove the stem. Caution: If the prosthesis is inserted incorrectly, it could bend and it will not fit into the female housing.



Place the attachment with self-curing resin. It is important to always use the protective disk around the perimeter of the attachment.



When OT Box Large is used, enlarge the space using a carbide bur to reduce interference with the male.



Fill the spaces with self-curing resin. Insert the prosthesis into the patient's mouth and have them bite down until the resin has cured.



Remove the prostheses and trim the excess resin.

FABRICATION OF FRAME FOR DIRECT ROOTS OR IMPLANTS



OT BOX CLASSIC
Glue the two OT Box sections together.



OT BOX CLASSIC
Separate the two housings and trim any excess material. Use only the part that is needed.

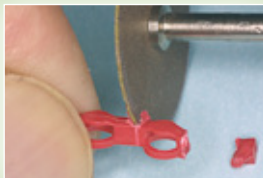

OT BOX SPECIAL
Separate the two housings and use only the part that is needed.

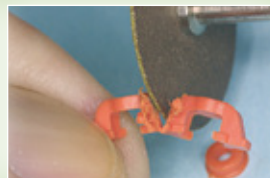

OT BOX LARGE
Separate the two housings and use only the part that is needed.



OT REVERSE 3
Stone model with analogs, denture setup and silicon guide.



Insert positioners in the analogs. Apply wax on the gingival crest. Make holes in the wax in contact with the stone. Be sure to use stone separator.

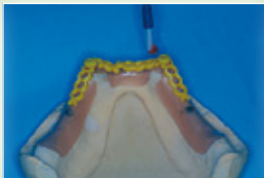

Position the sectioned OT Box housing of choice. Complete the reinforcement by using the castable connectors.



Join all of the components with self-curing resin. With the silicon mask in place, insert a wax pin for each tooth for additional support.



Remove the OT Box frame from model. Fill in any voids with wax.

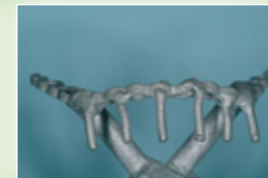

Sandblasted Cast Reinforcement



White or pink opaque can be used to block out the metal frame.



The finished prosthesis. Attachments are inserted into the cast housings.

The finished prosthesis on the stone model.



RECONSTRUCTIVE SPHERES - OT EQUATOR

Titanium + TiN coating



MULTIUSE

TITANIUM +
TiN COATING
more than 1600 Vickers

Available for any
implant system on the
market!

CONCAVE SPHERE

3 Sizes available:

Ø A	Ø B
2,5 mm	1,9 mm
2,2 mm	1,55 mm
1,8 mm	1,4 mm

OT EQUATOR

Size:	Ø B
Ø A	2,1 mm
2,5 mm	

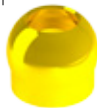
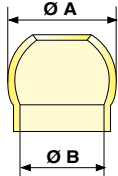

- A - Sphere support
- B - Sphere holder
- C - Strip holder
- D - Spatula for applying cement inside of the sphere.

For existing cases with worn spherical attachments which no longer provide adequate retention, the **DR8 UNDERSIZED CAP** can be used in the early stages of wear of the male component. This elastic cap offers an inner dimension of 1.7 mm and 2.2 mm which is smaller than Rhein83 normal and micro size caps and can be used with standard Rhein83 stainless steel housings.

When ball attachments show excessive wear, the **CONCAVE RECONSTRUCTIVE SPHERES** are recommended as the best long term restorative option. The **CONCAVE RECONSTRUCTIVE SPHERES** restore the worn male to it's original size of 1.8 mm, 2.2 mm or 2.5 mm diameter. **CONCAVE RECONSTRUCTIVE SPHERES** are manufactured with a Titanium Nitrite coating and are rated over 1600 Vickers hard.

The chairside procedure for using the reconstructive spheres is fast, easy and provides an economical alternative to replacing the old restoration.



Aqua caps are shown

DR8 Undersized Caps are available in 3 levels of retention for normal and 2 levels of retention for the micro size.

CLINIC

Dental attachments, like most other mechanisms, are subject to wear out. Rhein83 produces spheres for restoring worn ball attachments which restore and stabilize the prosthesis in a single appointment. Reconstructive spheres are bonded over the worn ball restoring the attachment to its original size.

CONCAVE RECONSTRUCTIVE SPHERE RESTORING A WORN OUT SPHERE



Insert the concave sphere into side A of the plastic tool. Fit over the worn out sphere in the mouth.



If the concave sphere does not fit passively, use a cylindrical bur (diamond or carbide) to slightly reduce the diameter. Check the fit again and repeat as needed.



Check the position of the concave sphere on the worn out sphere and finish by cleaning the two parts.

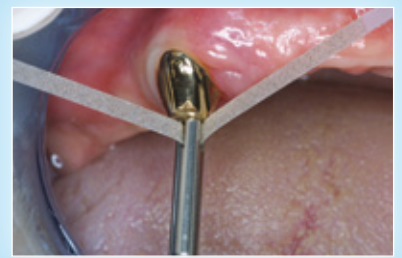

Additional surface can be removed by using side C of the tool. Insert a diamond strip into the notches, place the tool over the sphere and turn the manually.



Place a small amount of two-part self curing "metal to metal" resin inside the sphere.



Place the concave sphere over the worn sphere and wait for the resin to cure.



Once the resin has cured, remove any excess material.



The completed repair. The cap can be repositioned if necessary.

RECONSTRUCTIVE SPHERES

Titanium + TiN coating

Rhein83 offers two types of reconstructive spheres; A solid sphere and a concave sphere. Both types are titanium nitrate coated with a Vickers hardness rated over 1600. The Concave Reconstructive Spheres are available in 1.8 mm, 2.2 mm and 2.5 mm ball diameter. The Solid Reconstructive Spheres are only available with a 1.8 mm ball diameter. The Concave Sphere is used for restoring worn ball attachments and the Solid Sphere is used for restoring ERA® and CEKA® type attachments.

SOLID RECONSTRUCTIVE SPHERE RESTORING A WORN OUT RING ATTACHMENT



The worn-out female ring attachment.



Apply a small amount of two-part self-curing "metal to metal" resin on the bottom of the sphere. Insert the sphere into the attachment using the tool. Wait for the resin to cure.



The female attachment was converted into a male OT Cap Micro directly in the patient's mouth.

SOLID RECONSTRUCTIVE SPHERE RESTORING A WORN OUT OVERDENTURE BAR



Create a hole in the wall of the bar using a 1.6 mm ball drill.



Apply a two part composite to the shank of the sphere. Using the tool, insert the sphere into the hole. Wait for the composite to cure.



The sphere firmly cemented in place. The OT Strategy Cap can now be used in the prosthesis resulting in stability and retention.

SOLID RECONSTRUCTIVE SPHERE RECOVERY OF TITANIUM ABUTMENTS



A case with unknown titanium abutments. Worn out openings are present on top of the fixtures.



Solid Reconstructive Spheres are placed into the openings. A two-part self-curing "metal to metal" resin is applied.



Retentive caps are positioned into the existing denture. The denture is now stable and secure.

Solid RECONSTRUCTIVE Sphere

MULTIUSE

SOLID
"RECONSTRUCTIVE"
TITANIUM +
TIN COATING
rated over 1600 Vickers

TO REBUILD ANY
"RING" TYPE
ATTACHMENT
SUCH AS: ERA® AND
CEKA®

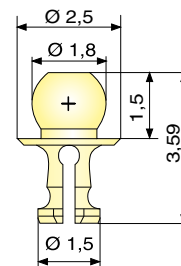

SOLID SPHERE
Micro Ø 1.8 mm



TOOL
to hold the
sphere



OT CEM is a self and photo curing cement. It is designed for permanent metal to metal bonding in the use of attachments in prosthetic implant solutions. Recommended for the following products:

- OT CAP TECNO
- CONCAVE SPHERE
- SOLID SPHERE
- COPING COVER
- THREADED SPHERICAL ATTACHMENTS WITH THREADED SLEEVES



The SOLID RECONSTRUCTIVE SPHERES can be bonded to the inside of hollow attachments or those with a female ring such as ERA® and CEKA®

Reconstructive Spheres can be used to repair various attachments available on the market. These attachments can be found in many types of prosthesis including overdentures, implants, roots and frameworks. If worn out or broken, they cannot be repaired easily.

The SOLID RECONSTRUCTIVE SPHERES offer a fast and easy cost effective alternative, transforming a female ring attachment into a male Micro OT CAP attachment. This repair can be completed chairside in a single appointment.

BAR AND CAST OVERSTRUCTURE

on the master model without duplication

OT Multiuse BAR + CONNECTOR

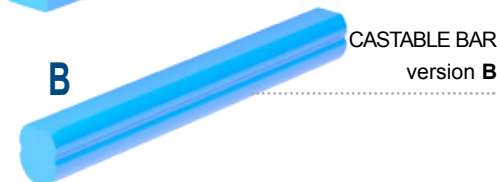

Universal castable bar for joining the CASTABLE BOX housings

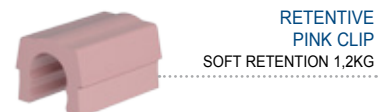
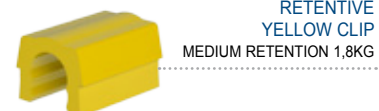
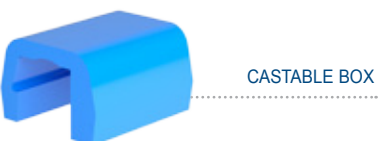

PARALLELOMETER MANDREL



The OT BAR MULTIUSE is designed with a 4 point retentive system. This unique system provides superior retention and can be utilized for both rigid and resilient functionality. With its innovative two-sided design (Side A is rounded and Side B side is flat), depending on the indication, either side can be used. If a resilient solution is required the bar is positioned with the flat side facing up or if a rigid solution is required then the bar is positioned with the round side facing up. OT BAR MULTIUSE can also be used as a connecting bar between canines in the anterior region.

OT BAR MULTIUSE and the cast housing are fabricated directly on the master model saving time by eliminating the need for duplication.

CLINIC

LABORATORY

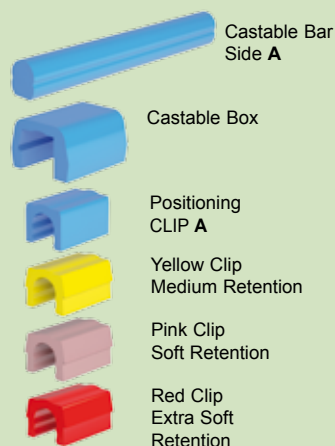
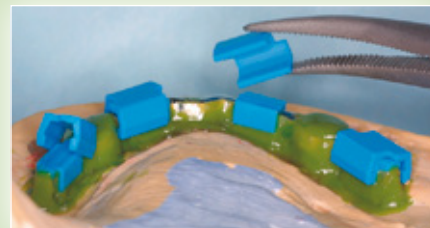

SIDE A

The rigid bar is used as a "connection" between two stable teeth where a "back and forth" motion is required. The bar can also be used in scenarios involving multiple abutments where the prosthesis is supported by a thin layer of soft tissue.

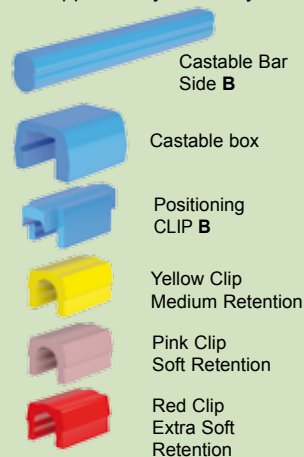

SIDE B

The resilient bar is most often used in scenarios involving multiple abutments where the prosthesis is supported by a "normal" layer of soft tissue.

CASTABLE BAR IN TWO VERSIONS

RESILIENT - RIGID

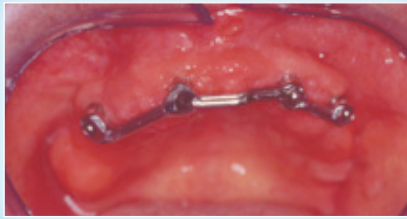

FABRICATION OF THE SUPERSTRUCTURE ON THE MASTER MODEL WITHOUT DUPLICATION

SIDE A - RIGID

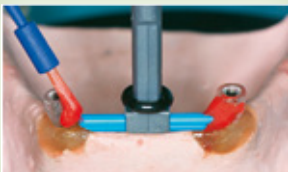

Mount the bar using Side A of the mandrel. Using resin or wax, complete the model.



The finished casting. Be careful not to wear out the retentive surfaces when polishing.



Block out any undercuts using wax and place Positioning Clips A on the bar.



To isolate, apply a small piece of tape (ex: teflon, Scotch) on the Positioning Clips A and on the cast bar. Insert the castable box housings.



To prevent resin from adhering to the bar, place a small piece of adhesive tape (ex: teflon, Scotch tape) over the bar. Use self-curing resin to connect the castable boxes.



Complete the model using wax and add castable connectors for extra reinforcement of acrylic. Sprue the model and cast.



The completed casting with retentive clips snapped in place.



The finished denture with cast reinforcement and retentive clips in place.

SIDE B - RESILIENT



Mount the bar using Side B of the mandrel. Using resin or wax, complete the model.



The completed casting. Use caution when polishing the surface. Be sure not to wear out the retentive undercuts.



Use wax to remove all undercuts. Apply a thin layer of wax on the top of the bar to create a cushion. Insert Positioning Clips B.



To isolate, apply a small piece of tape (ex: teflon, Scotch) on the Positioning Clips B and on the cast bar. Insert the castable box housings.



To prevent resin from adhering to the bar, place a small piece of adhesive tape (ex: teflon, Scotch tape) over the bar. Use self-curing resin to connect the castable boxes.



Complete the model using wax and add castable connectors for extra reinforcement of acrylic. Sprue the model and cast.



The completed casting with retentive clips snapped in place.



The finished denture with cast reinforcement and retentive clips in place.

EXTRACORONAL CASTABLE ATTACHMENTS

OT VERTICAL

CASTABLE TWIN CYLINDER ATTACHMENT
with centering and balancing pin

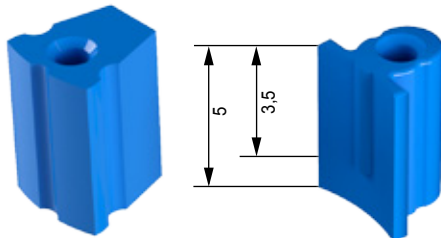

OPTIONAL STEADY

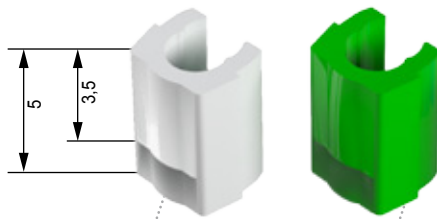

WHITE CLIP
Standard Retention

GREEN CLIP
Soft Retention

OT VERTICAL CLIPS
INSERTER/EXTRACTOR TOOL

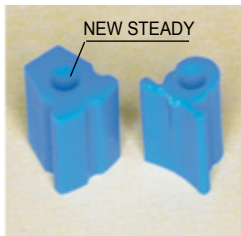
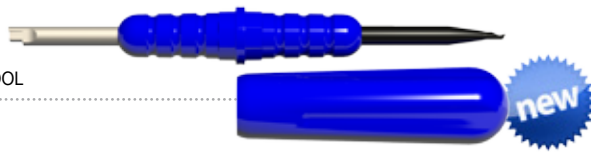

The cast metal guide pin is necessary to center, connect and balance the prosthesis during the final insertion. When milling or "cross arch" stabilization are not possible, the guide pin along with the **NEW STEADY** will provide lateral stability to the prosthesis. This ensures a longer life for the retentive clips. The vertical height of the attachment can be adjusted by reducing both male and female parts from the original length of 5 mm down to 3.5 mm according to the pre-marked notches. Reducing the vertical height creates no difference in functionality. Removal and replacement of clips can be easily performed by the Dentist chairside.

LABORATORY

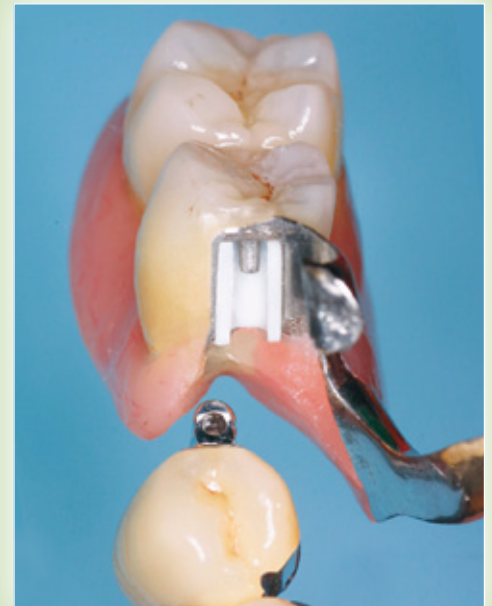

The ot vertical attachments and retentive clips can be lowered in height, in order not to risk inconveniences, it is advisable not to shorten them beyond the indicative sign * of 3.5 mm.

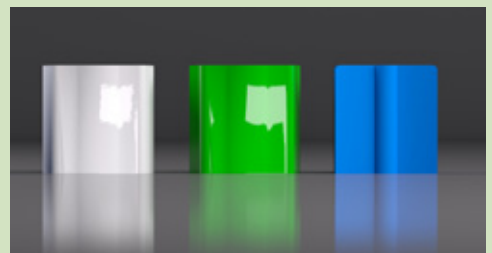

TECHNIQUE: SINGLE CASTABLE MALE ASSEMBLY



Parallelometer Key: insert the plug into the hole of the attachment, rotate a few times to obtain the correct seal and be able to slide it out comfortably after fixing the attachment in the wax.



Completed the assembly and the wax modeling, close the hole with wax and create a lingual drilling, proceed with the sprue of the product.



Crowns with cast connection, finished and polished milling.



Retentive clip inserted on the cylindrical male. Waxed model (be careful not to dirty the coping with wax before duplication).



Duplicate model in coating with reproduction of the clip format.



Melted and sanded framework.

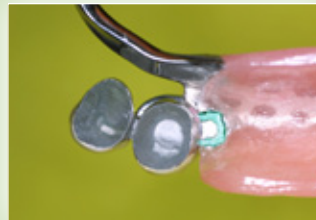

Finished work, green retentive clip inserted into the framework.



Work finished.

TECHNIQUE: CALSTABLE MALE + STEADY ASSEMBLY

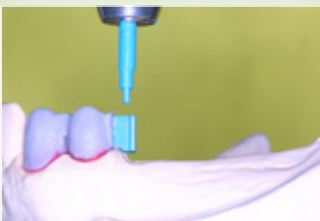

Parallelometer key: insert the plug into the hole of the adapted Steady to follow the mucous profile, rotate to remove the key after fixing it.



Place the Ot Vertical male gluing it lingually to the Steady and complete the waxing.

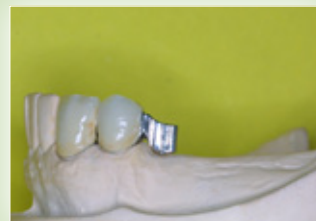

Crowns with molten attachment, the Steady and Vertical have been adapted to the mucosal profile.



Retentive clip inserted on the cylindrical male. Model discharged with wax (be careful not to dirty the coping with wax before duplication).



Duplicate model in coating with reproduction of the Steady format and clip.



Framework molded, cover with the wax the Steady portion to have an insertion guide and stability when melted.

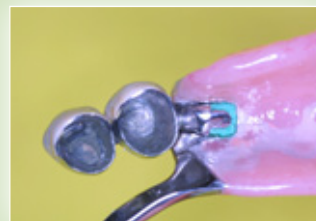

Framework placed on the Steady



Framework on the model. Stability is guaranteed even without milling, thanks to the Steady

COMBINED RETENTION ATTACHMENT

For Multi-Functional Prosthetics

OT UNILATERAL



RETENTIVE CAPS OT CAP Micro

-  Clear • Standard
-  Pink • Soft
-  Yellow • Extra Soft
-  Green • Elastic
-  Black • Processing

RETENTIVE CAPS OT Strategy for duplication

-  Clear • Standard
-  Pink • Soft
-  Yellow • Extra Soft
-  Black • Processing

TOOLS



OT STRATEGY CAPS INSERTER/EXTRACTOR TOOL

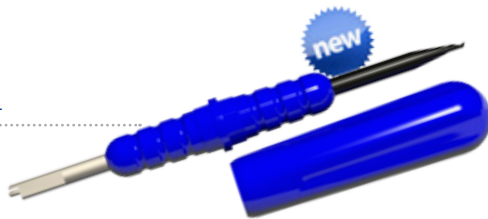

The OT UNILATERAL castable attachment from Rhein83 is specifically intended for unilateral, bilateral or implant bar applications without additional support from milled bracing arms.

OT UNILATERAL's exclusive design features a two-in-one combination of 1.8 mm horizontal and vertical spheres utilizing OT CAP and OT STRATEGY micro size female caps. The male section of the attachment is engineered with a vertical strut which extends through the base of the attachment providing exceptional lateral stability and distal support to the prosthesis.

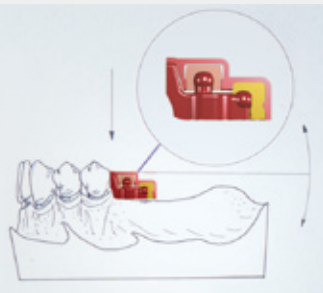

The Uni-Box female component is a one piece castable housing that covers the entire male section, adding superior strength to the acrylic.

LABORATORY



EXCLUSIVE FEATURE

2-IN-1 DESIGN - A COMBINATION OF HORIZONTAL AND VERTICAL MICRO SPHERES ARE USED WITH THE OT CAP AND OT STRATEGY ATTACHMENT SYSTEMS



MULTIPLE BENEFITS

BECAUSE OF IT'S UNIQUE DESIGN, OT UNILATERAL PROVIDES:

- * LATERAL STABILITY
- * NO MILLING REQUIRED
- * SUPERIOR RETENTION
- * CONTROLLED RESILIENCY
- * OVERALL FUNCTIONALITY
- * ECONOMICAL SOLUTIONS

UNILATERAL SADDLE: ATTACHMENT AND OVERSTRUCTURE UNIQUE PHASE SETTING UP



Positioning of the OT UNILATERAL bar using the OT CAP paralleling mandrel by starting with the analysis of the masticatory plan. Proceed by connecting the bar to the last modeled wax crown.



Place the positioning ring over the OT CAP micro sphere. Place the castable OT BOX component in position, the positioning ring will assure the proper position.



Join the Uni-Box component to the connector by using a pattern resin in order to reinforce the structure. Be careful not to have any material inside the Uni-Box component.



Remove the positioning ring by the OT CAP sphere and proceed with the sprue procedure.



Unique fusion is one of the best features of the UNILATERAL attachment.



Fused UNILATERAL and Uni-Box. Sandblast the casting by keeping attention not to "over-sandblast" the spheres. Insert the black laboratory caps and proceed by polishing the sphere.



In order to provide the optimal stability, wax-up carefully the saddle in order to embrace the ridge as much as possible.



Completed procedure: proper retentive caps (adequate degrees of elasticity) are placed inside the fused Uni-Box component

BILATERAL STRUCTURE: RESILIENT FUNCTIONALITY AND FREE MILLING PROCEDURE



Place the positioning ring over the OT CAP micro sphere. Place the castable OT BOX component in position, the positioning ring will assure the proper position.



Finished work: Ot cap and Ot Strategy caps, with the proper retention features, are inserted inside the Ot-Box component.

IMPLANT SUPPORTED BAR: DISTAL EXTENSIONS AND COMBINED FUNCTIONALITY



Once the components to build the bar are inserted, place the OT UNILATERAL bar by using the OT CAP mandrel and by analyzing the masticatory plan. Connect it then distally to the modeled bar.



Cast bar thanks to the combined functionality of the OT UNILATERAL. The prosthesis will count on a improved stability without any additional stress over the implants.

LOCKING PIN - TITANIUM

DT LOCK LOCKING PIN TITANIUM

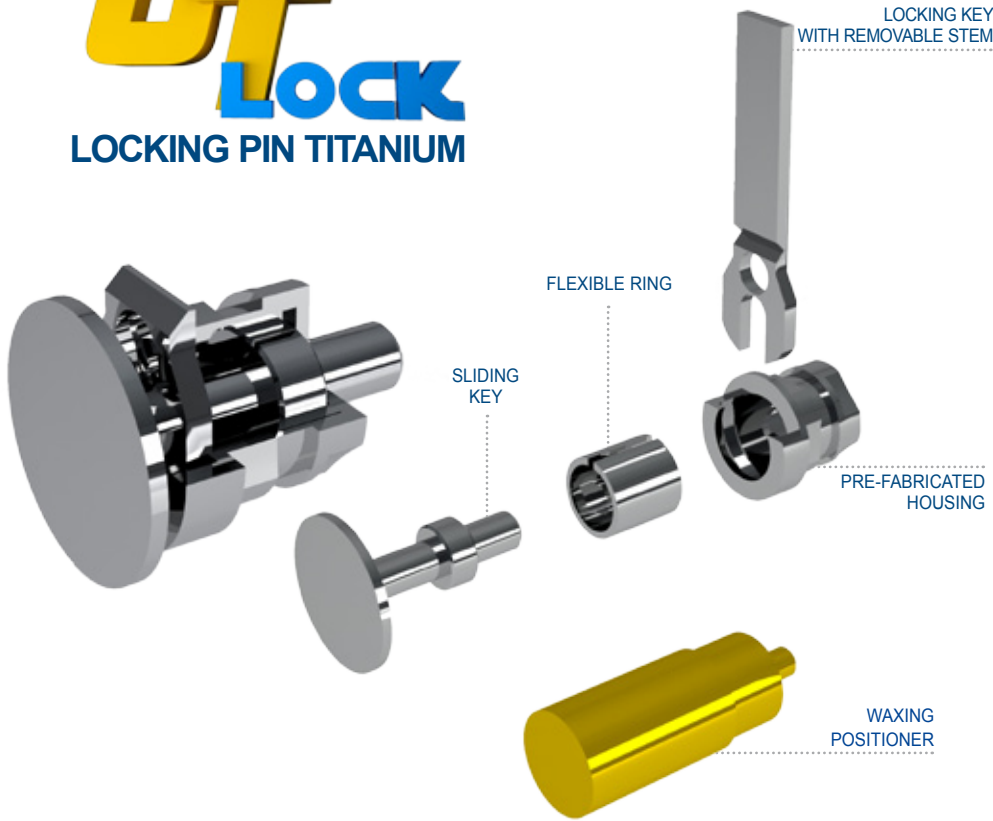

CLINIC

OPTIONAL
for the patient

CONICAL GUIDE AND UNLOCKING TOOL



UNLOCK THE PROSTHESIS BY INSERTING THE UNLOCKING TOOL INTO THE CONICAL GUIDE.

ADJUSTABLE TITANIUM LOCKING PIN

SPACER RING SYSTEM TO POSITION THE KEY TO THE DESIRED SHAPE

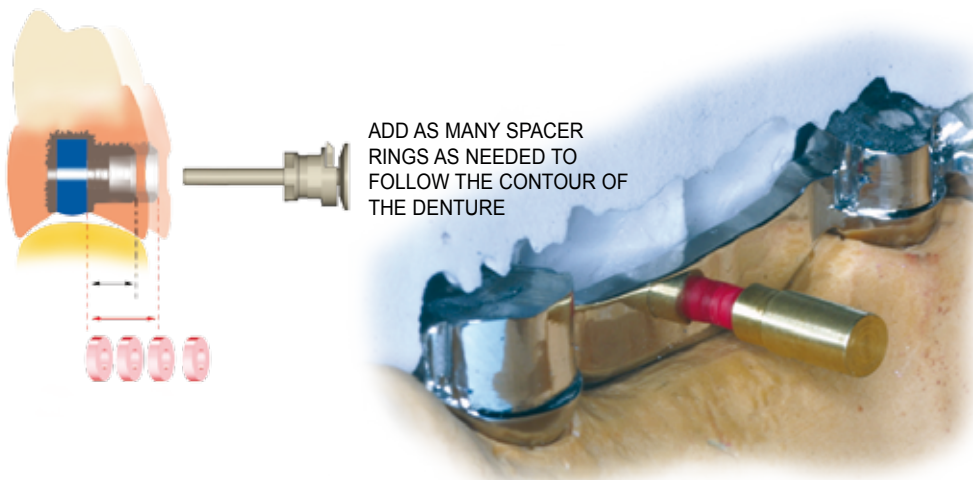
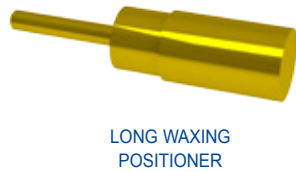

LABORATORY

LOCKING KEY IN POSITION WITHOUT SPACER RINGS

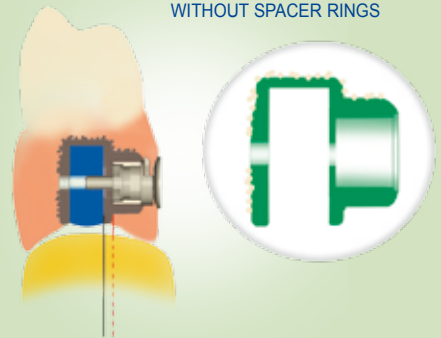

LOCKING KEY POSITIONED USING SPACER RINGS TO FOLLOW THE CONTOUR OF THE DENTURE

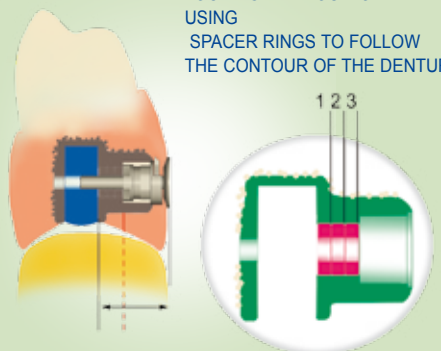

LABORATORY

DT TITANIUM LOCK

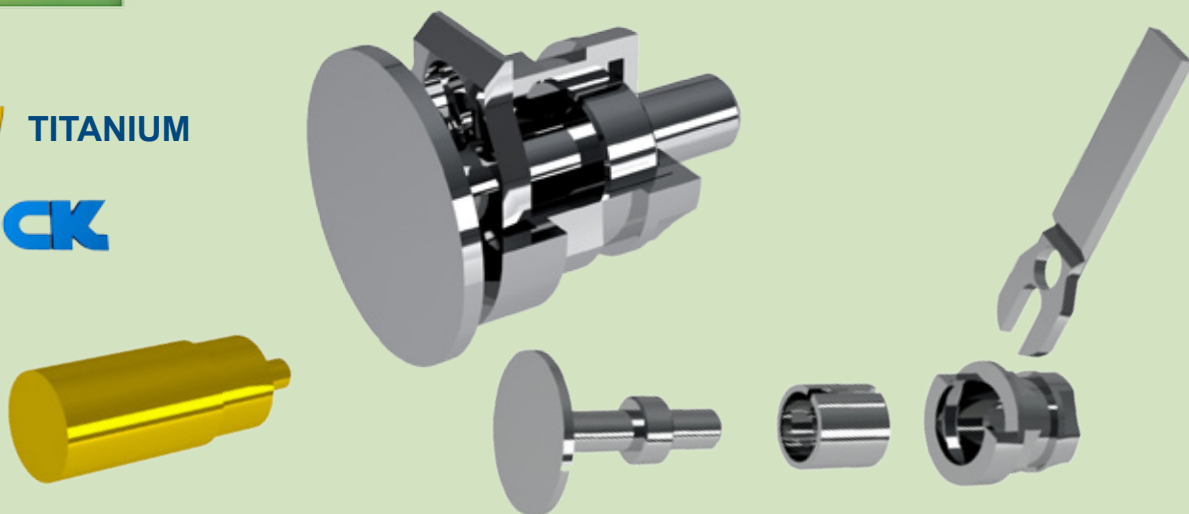

Model the bar in resin and drill a 0.8 mm hole in the most ideal position.



Insert the ceramic pin through the hole.



The finished and polished bar.



Insert the housing shaper into the hole and lock it in place using resin. Be sure not to go past the "STOP" when applying resin.

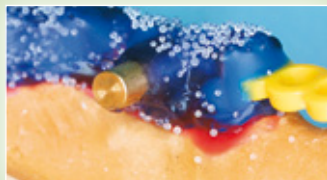

Using resin, complete the model of the superstructure up to the "STOP". Remove the housing shaper and cast.

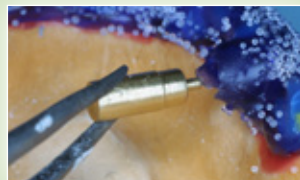

Pull out the brass positioner and cast.



Insert the pre-fabricated housing and bond.



Insert the positioner again. Proceed with wax and cure the resin.

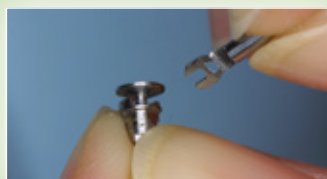

Insert the locking key into the pre-fabricated housing guide. The "key-ring" mechanism is now locked.



Bend the locking key and brake it.

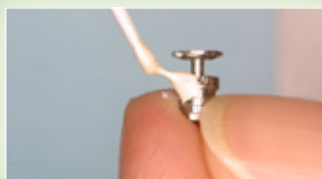

Apply the self-hardener composite material to stop the locking key and insert the locking pin in the hole.



Locking Pin locked in position. Finish and polish.



Finished prosthesis. Determine whether or not to use the EXTRACTOR KEY

OVERDENTURE ATTACHMENTS - SPHERO FLEX - SPHERO BLOCK

Rotating & Stationary Ball Abutments For Divergence Correction

TITANIUM + TIN COATING PROVIDES 1600 VICKERS HARDNESS

Sphero FLEX

"SELF-PARALLELING" SPHERES

2.5 mm

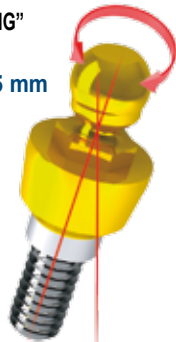

Sphero BLOCK

STATIONARY BALL 1.8 mm ABUTMENT

2.5 mm



OT Special BOX

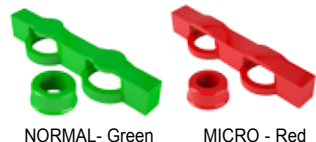

NORMAL - Green

MICRO - Red

OT Classic BOX



NORMAL SIZE = Green + Yellow
MICRO SIZE = Red + Yellow

STAINLESS STEEL AND TITANIUM HOUSINGS Normal / Micro for curing welding or bonding

ELASTIC RETENTIVE CAPS Normal / Micro



TITAN CAP Normal / Micro

EXTRA RESILIENT CAPS



Gold • Elastic
Silver • Elastic Gummy



DIRECTIONAL RINGS (REQUIRED FOR LAB AND CLINICAL PROCEDURES)

IMPRESSION COPING Normal / Micro size

ANALOGS SPHERO FLEX / SPHERO BLOCK



PROTECTIVE DISK

UNIVERSAL KEY + HANDPIECE CONNECTOR



MANUAL TORQUE WRENCH

For Sphero block - flex and Ot Equator
15/35Ncm Strength - Max 50Ncm torque, suggested 25Ncm.



CONNECTOR For OT Box



The Sphero Flex implant overdenture attachment is compatible with all implant systems currently on the market. Featuring a rotating ball with a diameter of 2.5 mm that is flexible to 7.5° in all directions. When used with a 14° directional ring, Sphero Flex corrects divergence up to 43° between two implants. Sphero Flex creates a passive path of insertion which reduces trauma to the implant.

Sphero Block is a "one-piece" milled stationary ball implant attachment. It is available in 2.5 mm and 1.8 mm diameters. Sphero Block provides exceptional stability and corrects divergence up to 28° between 2 implants. Sphero Block implant attachments are compatible with all implant systems currently on the market.

Sphero Flex and Sphero Block are manufactured with cuff heights ranging from 1 mm to 7 mm. NOTE: The Sphero Flex and Sphero Block attachments are available for all platform diameters.

CLINIC



DIRECTIONAL RINGS CORRECT PLACEMENT

Before placing the impression abutment on the implant it is suggested to put a gray directional ring (for parallel systems) or a ring for angled implants if not parallel. This will keep the impression coping "on level" during the impression. The directional rings have only one direction of insertion.

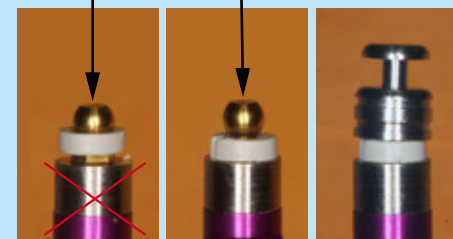

Wrong placement

Correct placement

LABORATORY

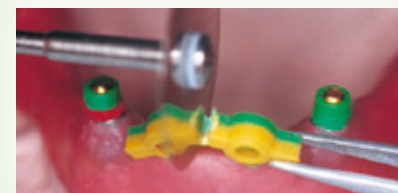
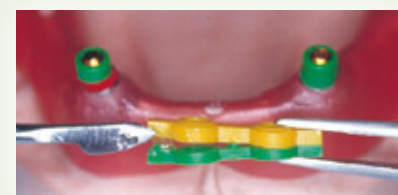

3 EASY STEPS

1. Place directional rings (green and red are shown here) over the spheres establishing a level plane.
2. OT BOX positioners are placed over spheres to support box housing during framework fabrication.
3. After gluing the 2 OT BOX parts, cut and use the necessary pieces for the housing.

OVERDENTURE ATTACHMENTS - SPHERO FLEX - SPHERO BLOCK

Rotating & Stationary Ball Abutments For Divergence Correction

CHAIRSIDE PROCEDURE FOR POSITIONING THE CAPS



Screw the attachment into the implant. For best results, unscrew and screw the attachment 3/a times and then tight firmly.



Select the appropriate directional rings and place them over the spheres. Be sure that the ring is aligned with the hex and seated properly on the platform.



Once the directional rings have been positioned, it is advisable to remove the retentive caps and place a protective disk over the spheres. Replace the retentive caps in original position when finished.



Try the prosthesis in the mouth. Check to see if there is enough space for the retentive caps. Fill the holes with self-curing resin and position the prosthesis over the caps and spheres in the patient's mouth.



Once the resin has hardened, remove the prosthesis. Remove the protective disk along with any excess resin.



Finished prosthesis

TAKING IMPRESSION TRANSFER



Place the directional ring over the sphere with the flat side facing down. Place the impression coping over the sphere.



Rotate the directional rings to achieve a common axis parallel to the occlusal plane and take the impression.

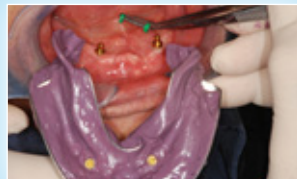

Remove impression. Directional rings must be removed from the impression and spheres.



Place the analogs into the impression copings and send to the laboratory for model fabrication.

OT BOX CLASSIC NORMAL - CAST REINFORCED ACRYLIC PROSTHESIS USING DIRECTIONAL RINGS



Place directional rings over the spheres. OT BOX is placed over the directional rings, ensuring that the horizontal plane is level. Connect with resin.



The constructed OT BOX substructure with reinforced wax pins. Sprued and ready for casting.



The cast substructure on the model. The metal reinforcement pins for each tooth are positioned according to the silicone mask.

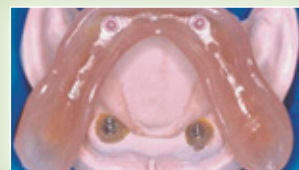

Finished prosthesis with caps inserted in the cast OT BOX housings.



Screw the abutment into the analog. Be sure to use the abutment with the proper cuff height.



Directional rings are placed over the abutments and must be fully seated on the platform. Rotate rings until they are parallel in the same horizontal plane.



The nylon caps are inserted into the stainless steel housings and placed on top of the directional rings. Verify that the caps are still in the same horizontal plane.



The finished prosthesis with stainless steel housings and retentive caps in final position.

IMPLANT OVERDENTURE ATTACHMENTS

Components and Accessories

DIRECTIONAL RINGS

for angle correction

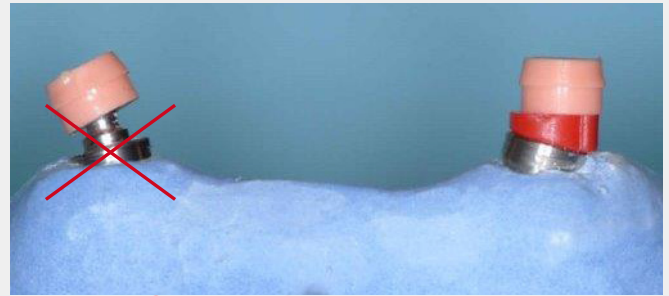
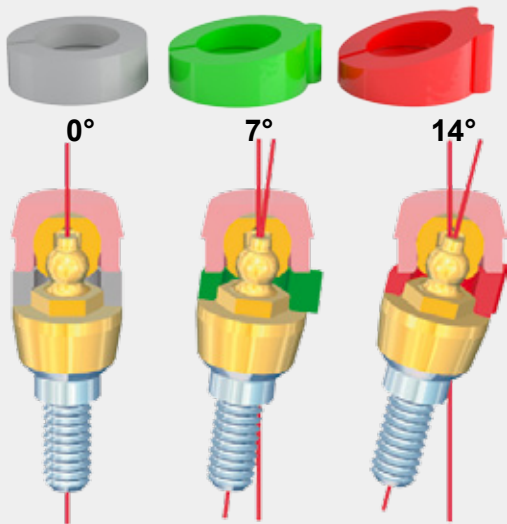

Sphero FLEX

Sphero BLOCK
Normo/Micro

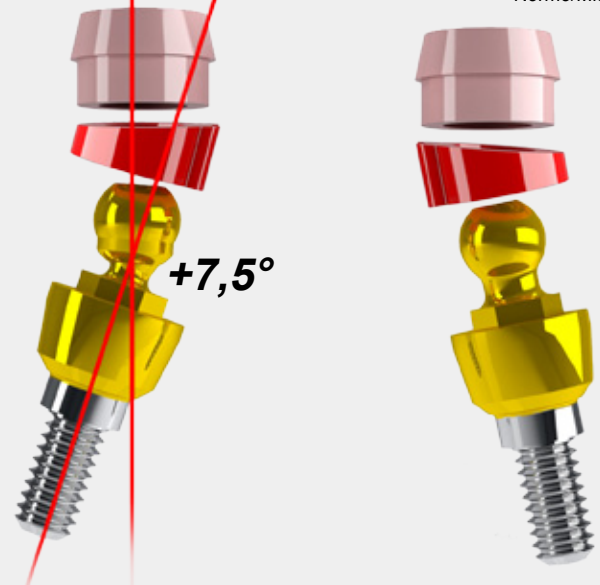

SPHERO FLEX - SPHERO BLOCK

In order to achieve a passive fit for the final prosthesis using the SPHERO FLEX and SPHERO BLOCK attachment systems, it is necessary to use DIRECTIONAL RINGS. When not used, there is a high possibility that the attachments will not seat properly into the prosthesis due to incorrect positioning of the caps. This mis-alignment will result in premature wear of the caps causing additional trauma to the implant. SELECTION OF DIRECTIONAL RINGS: The position and angulation of the implant will determine which directional ring will be used. For parallel implants, a 0° DIRECTIONAL RING can be used. For implants that have greater divergence, a 7° or 14° ring can be used.

Place the DIRECTIONAL RING onto the hex of the attachment with the flat side down. Be sure that the ring is fully seated. Next, place the retentive cap onto the sphere and rotate the DIRECTIONAL RING until the cap is parallel with the other caps and are in the same horizontal plane. This ensures that the retentive caps are correctly alligned inside of the final prosthesis.

INSTRUCTIONS FOR USE OF ABUTMENT DRIVER / WRENCH

Abutment Driver has a sliding mechanism that locks it onto the ball abutment. This needs to be fully engaged to properly tight the abutment without damaging the abutment. To dis-engage driver once the abutment is tightened in the mouth push down on the silver portion to loosen the driver from the abutment (Please screw and unscrew the abutment 3/4 times in order to achieve a fine adaption of the two threads). Then tight the abutment with a torque controller or the manual torque wrench.

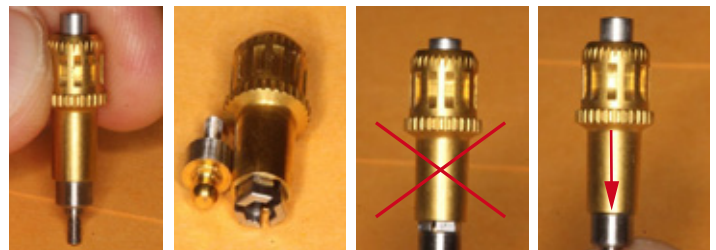

Clamping mechanism

Incompletely seated driver

Driver fully seated

UNIVERSAL "ANTI-UNSCREWING" SYSTEM WITH ELASTIC INSERT

Recommended for Sphero Flex, Sphero Block and OT Equator attachments with a cuff height over 5 mm. This system can also be used for single screws. (Core Vent, Branemark, Pitt Easy, Bona Fit)

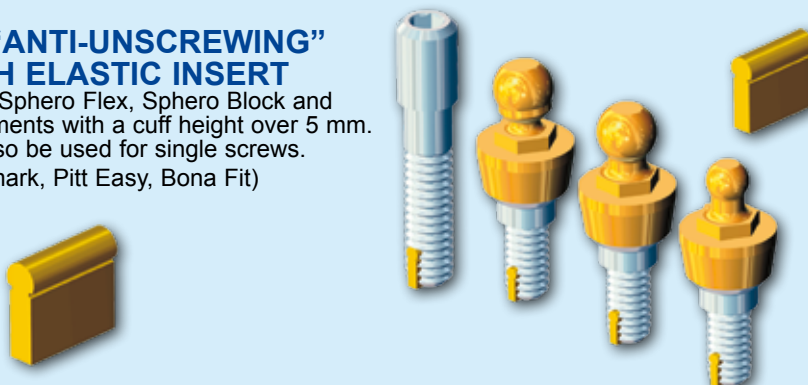

ELASTIC INSERT

This component is manufactured from bio-compatible materials with an "elastic" memory. While screwing in the attachment, the insert is compressed. When the threaded attachment is fully seated, the elastic insert will expand and return to its original form, which prevents rotation and unscrewing of the device. The insert is applied at the manufacturing facility UPON REQUEST. It can be applied to any screw with a diameter greater than 1.8 mm.

MINI-PARALLELOMETER

FEATURES:

- EASY TO USE
- COMPACT
- PRECISE
- ECONOMICAL



The **MINI-PARALLELOMETER** allows accurate positioning of attachments without the need for an expensive milling machine. The **MINI-PARALLELOMETER** is a useful and economical device for the laboratory technician that can be used in day-to-day operations or in a training environment.

INSTRUCTIONS FOR USE

Place the stone model on the swivel base. Rotate the base until the ideal model position is found. Insert the mandrel into the notch on the horizontal extension arm and lock it into place by tightening the screw. Adjust the height by moving the horizontal arm up and down. Once the correct height has been found, lock the arm into position by tightening the rear locking screw.



To determine the tissue height above the implant and eliminate mistakes when choosing the correct attachment, the Cuff Height Measuring tool is recommended.

The Cuff Height Tool is compatible with all implants that have an internal or external hex connection.

Cuff Height Measuring Tool
With Threaded Pin And Ball Indicator

With easy to read color-coded millimeter measurements, Dentists and dental laboratories can accurately measure tissue height between .5 mm and 7 mm. The ball indicator outlines where the male component of the attachment will seat above the tissue.

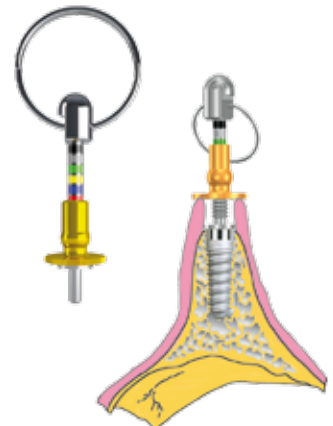

Cuff Height Measuring Tool
With Stationary Pin

The cuff height measuring tool with stationary pin provides the same functionality as the tool with a threaded pin, however it is used in cases where there is limited space between two implants.

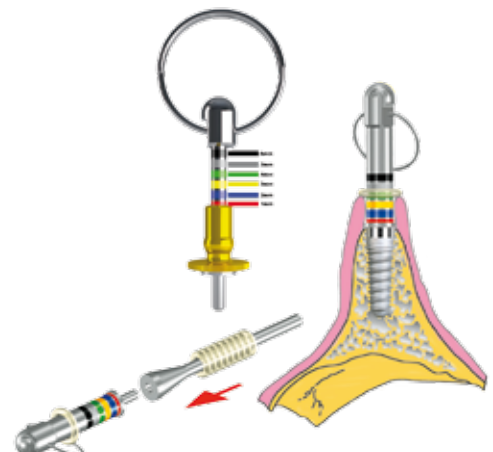

CUFF HEIGHT MEASURING TOOL FOR IMPLANTS

INSTRUCTIONS FOR USE

1. Rotate upwards the gold colored plate until the tool is completely open.
2. Insert the tool into the implant. Be sure that it is fully seated on the top of the implant.
3. Firmly hold the tool and rotate the gold plate clockwise until it contacts the ridge.
4. Remove the tool and read the color coded rings indicated on the pin to determine the cuff height.

NOTE:

When a colored ring is completely covered, and only the silver band between colors is visible, it is recommended to utilize the next (higher) color.

IMPORTANT:

Before ordering an attachment, it is necessary to specify: Implant manufacturer, implant brand, diameter, internal or external hex connection and cuff height. The cuff height is determined by taking the corresponding color from the cuff height measuring tool. For implants with an internal hex connection the cuff height will range from .5 mm to 7 mm and for implants with an external hex connection, the cuff height will range from 1 mm to 7 mm.

BROKEN SCREW EXTRACTOR KIT FOR IMPLANTS

FOR REMOVAL OF BROKEN IMPLANT SCREWS



READILY AVAILABLE FOR CORE VENT AND BRANEMARK COMPATIBLE IMPLANTS
EXTRACTOR KITS CAN BE MADE TO ORDER FOR MOST common IMPLANT BRANDS WITH AN INTERNAL OR EXTERNAL HEX CONNECTION



Claw reamer bur (C) inserted in the positioner (B) for manual removal of the broken screw

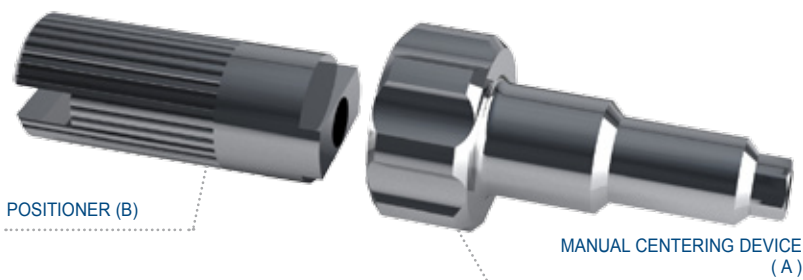

PARTS AND ACCESSORIES:

- A MANUAL CENTERING DEVICE
- B POSITIONER
- C CLAW REAMER BUR
- D REVERSE CUTTING BUR

CLINIC

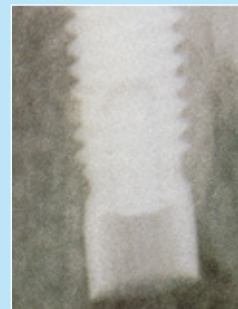

BROKEN SCREW VISIBLE IN X-RAY OF IMPLANT



BROKEN SCREW REMOVED

REMOVING THE BROKEN SCREW WITH THE CLAW REAMER BUR

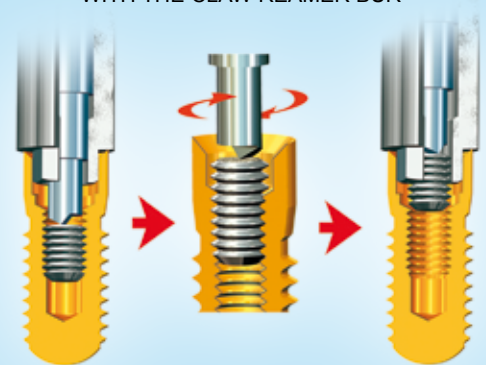

With the Rhein83 Broken Screw Extractor Kit, it is possible to remove a broken screw from an implant if it has not been bonded or damaged during previous attempts to remove it.

The extractor kit includes two types of burs; a claw reamer bur and reverse cutting bur. In addition, the kit includes manual centering devices to hold the burs in place during the procedure. In 90% of cases, the broken screw can be removed easily with the claw reamer bur. However if the broken screw is firmly stuck inside the implant, the reverse cutting bur must be used.

Broken Screw Extractor Kits are readily available for Core Vent and Branemark compatible implant systems. Other kits, both with internal and external key can be ordered upon request.

To order a custom kit or for technical support, please contact your local Rhein83 distributor.

BROKEN SCREW EXTRACTOR KIT FOR IMPLANTS

FOR REMOVAL OF BROKEN IMPLANT SCREWS

USING THE REVERSE CUTTING BUR TO EXTRACT A BROKEN SCREW

Place the reverse cutting bur into the angled handpiece and then insert it into the respective extractor. Before activating the handpiece it is essential that the bur is in contact with the broken screw. Activate the handpiece in a counter clockwise direction and be sure that firm downward pressure is maintained throughout the procedure. It is mandatory to set the rotating ratio between 400 and 600 rpm in order to avoid the implant and the bone overheating. To prevent the implant fixture from overheating, it is necessary to move the reverse cutting bur in an up and down motion intermittently. Upon removing the broken screw, be sure to clean the implant fixture thoroughly to remove any residual metal leftover that remain from the extraction procedure.



Operate between and 2000 rpm

NOTE: Before using, fill the bottom hole (side with the hex) of the centering device with petroleum jelly. In addition to lubricating the device, in some cases, it will hold the broken screw in the extractor upon removal.

USING THE CLAW REAMER BUR WITH THE MANUAL CENTERING DEVICE

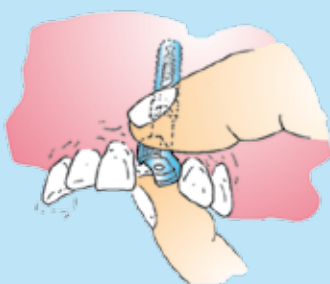

Fig.1

While holding the manual centering device firmly, insert the device (A) into the fixture and make sure that the hexagon is fully engaged into the implant fixture.

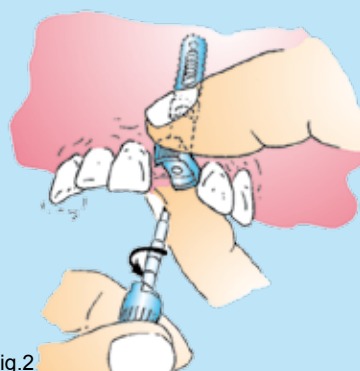

Fig.2

Insert the claw reamer bur (C) into positioner (B). Insert the bur into the centering device until it comes into contact with the broken screw. Rotate in a counter clockwise direction while maintaining constant downward pressure. After a few turns the notch in the bur should reappear. Manually remove the centering device which will contain the screw, if not it will remain inside the implant and can easily be removed with tweezers.

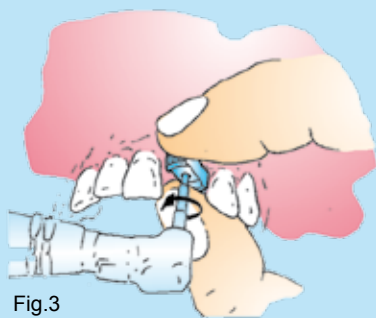

Fig.3

In certain cases, it may be easier to use the claw reamer bur (C) with a contrangle handpiece. With the motor stopped, insert the claw reamer bur into the centering device (A) until the tip touches the broken screw.



Fig.4

While applying pressure to the broken screw, start the motor in a COUNTER CLOCKWISE direction at a low RPM. After a few turns the notch in the bur should reappear. Manually remove the centering device which will contain the screw, if not it will remain inside the implant and can easily be removed with tweezers.

IMPORTANT: Please follow the instructions closely when using the Broken Screw Extractor Kit. Although the Reverse Cutting Bur has been hardened by a tempering process, it should always remain vertical (parallel with the screw hole) during the procedure to prevent breakage. The Reverse Cutting Bur and Claw Reamer Bur are subject to wear. These burs should be inspected for wear prior to each procedure and replaced if necessary. Finally, it is very important that the motor direction is set to COUNTER CLOCKWISE when using this kit.



REPLACEMENT OF CAPS

Rhein83 recommends that caps should be replaced every 12 months. The longevity of the caps is affected by many variables including: original case design, patient hygiene and general maintenance of the prosthesis.



HOW TO REPLACE THE CAPS

In a prosthesis with metal housings, the cap can be removed by using the extractor tool for caps; otherwise use a spherical bur at low RPM without damaging the housing.



In a prosthesis where the cap is incorporated directly into the resin, it can be removed by hand with a pointed instrument (such as a spatula) or the Rhein83 cap extractor tool. If a bur is used, be careful to remove only the retentive cap and to not modify the form that remains in the resin. If the resin site is damaged during the removal of the cap, repair the area with self curing resin before inserting the new cap. The cap insertion tool is used for this procedure.

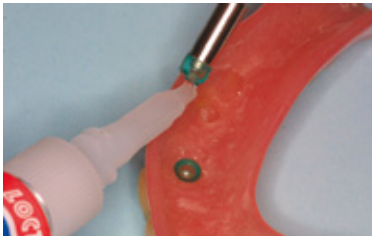

GREEN ELASTIC CAPS

These caps are highly elastic and have a medium level of retention. In cases where metal housings are used, it is recommended to apply a drop of adhesive (cyanoacrylic) on the inside of the housing before inserting the cap.

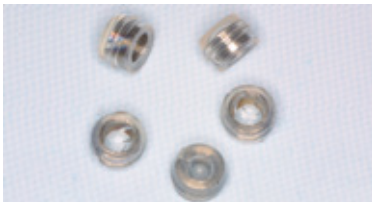

TITAN CAPS

These caps were designed to be used on the [OT CAP TECNO](#) as well as the Normal and Micro attachments with machined titanium spheres.



CAP INSERTION TOOL

When using high retention caps, it is recommended to insert them directly in the clinic into the housing using the cap insertion tool.

[OT CAP Normal](#) / [Micro OT Reverse](#).



PROSTHESES WITH MULTIPLE ATTACHMENTS

In order to balance the retentive levels of a prosthesis with multiple attachments, it is possible to use caps with different levels of retention.

REAMERS AND CAP TESTERS: if the retention of the caps is too high, insert the reamer into the caps and rotate it in a clockwise direction, after only a few rotations it will wear down the perimeter which will reduce the retention. Try the prosthesis in the mouth, if it is still too retentive, repeat the operation with the reamer. In order to avoid trying the prosthesis in the mouth too many times, one can use the spherical tester, in order to evaluate the holding strength.

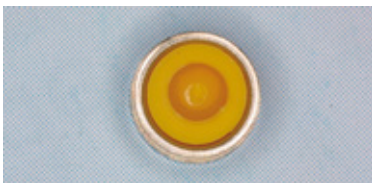

HOW THE RETENTIVE CAP FUNCTIONS

The Rhein83 caps are manufactured with a high elasticity which creates both mechanical and frictional retention resulting in a larger contact zone between the cap and the lower portion of the sphere. A small space between the metal housing and the cap allows the cap to expand as it passes over the equator of the sphere. Once completely engaged, the cap returns to its original form.



POLISHING OF THE "CAST" ATTACHMENTS:

It is recommended that only glass beads or a soft cloth wheel are used to polish attachments. In order to avoid damage to the sphere during these procedures, it is a good practice to cover the spheres with a retentive cap. The retentive caps can be reused again for this procedure.

TRADITIONAL PROSTHESES



REF.

DESCRIPTION

06P

Model with upper prosthesis with OT Cap
Normal / Micro size attachments:
1 OT CAP NORMAL
1 OT CAP MICRO
1 Frame with OT BOX mono housings
5 Acrylic teeth



07P

Model with lower prosthesis with OT Strategy
1 OT STRATEGY
1 OT STRATEGY + STEADY
1 Frame with caps and duplicated housings
5 Acrylic teeth



04P

PROSTHESIS ON NATURAL TEETH
Model with lower "Overdenture" prosthesis:
1 PIVOT FLEX titanium post
1 Cast post with OT CAP sphere
1 Complete denture with 14 teeth
1 Cast OT BOX reinforcement incorporated in the denture

04P/A

Same model as 04P. Denture with pre-fabricated
STAINLESS STEEL HOUSINGS for retentive caps



09P

MODEL WITH LOWER PROSTHESIS WITH OT VERTICAL
1 OT VERTICAL
1 OT VERTICAL + STEADY
1 Frame with clips and duplicated housing
6 Acrylic teeth



031

IMPLANT MODELS

Model with lower prosthesis with SPHERO FLEX abutments:
2 Implant analogs
1 SPHERO FLEX
1 SPHERO BLOCK
1 Complete denture with 14 teeth
1 Cast OT BOX reinforcement incorporated in the denture

031/A

Same model as 031. Denture with pre-fabricated
STAINLESS STEEL HOUSINGS

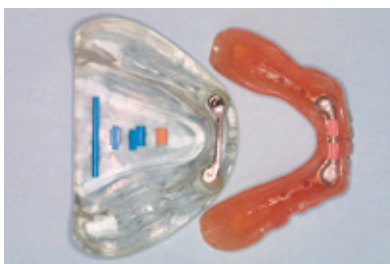

08B

PROSTHESIS ON FIXTURES

Model with lower prosthesis with OT Bar Multiuse:
2 Implant analogs
1 Cast bar with copings
1 OT BAR MULTIUSE
1 Cast superstructure with two retentive clips
1 Complete denture with 14 teeth

PRODUCT SPECIFICATIONS

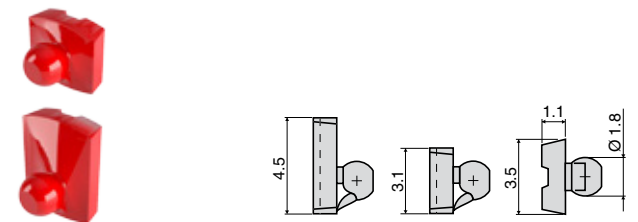
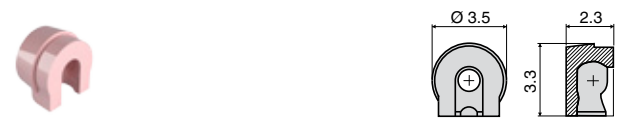
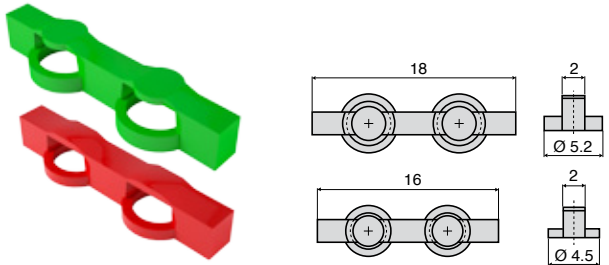
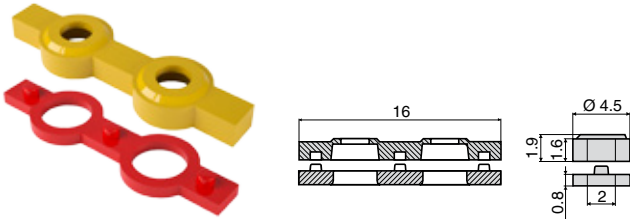
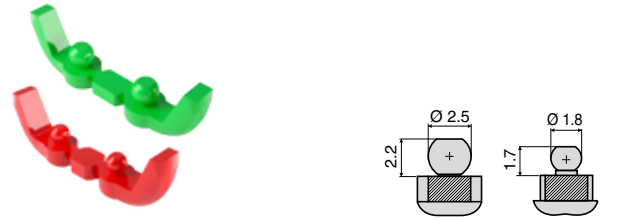
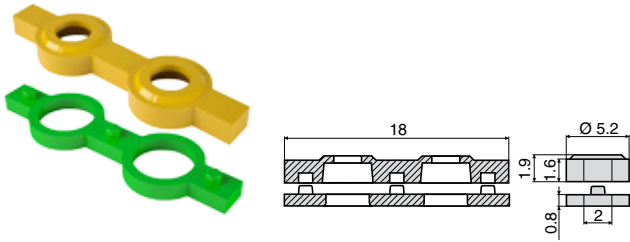
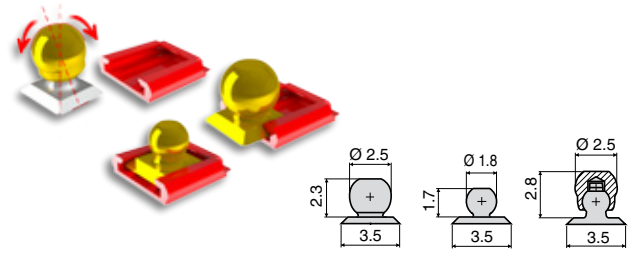
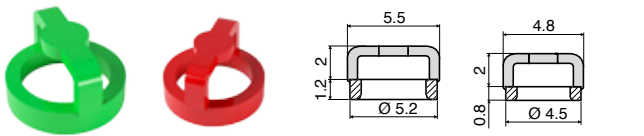

PRODUCT RANGE - SIZES AND DIMENSIONS

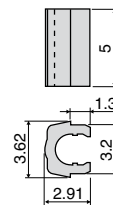
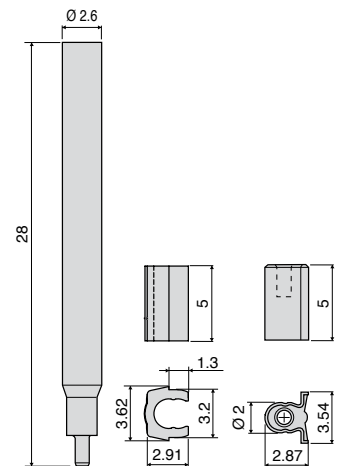
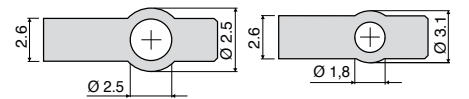
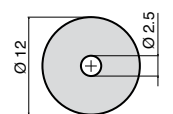
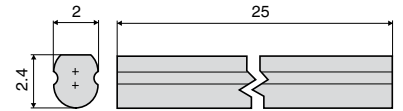
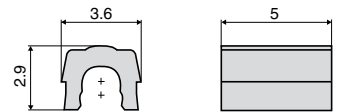
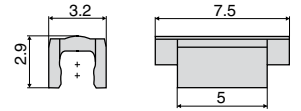
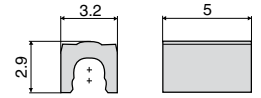
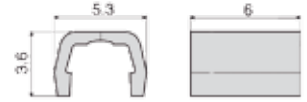
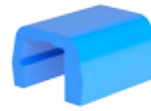
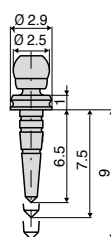
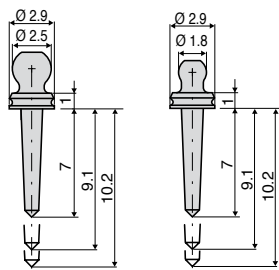
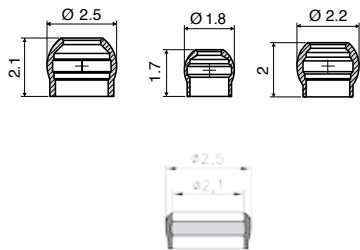
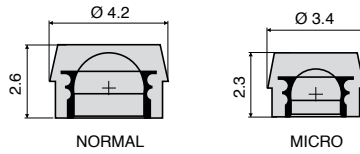
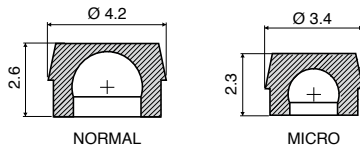
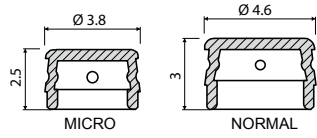

PRODUCT SPECIFICATIONS

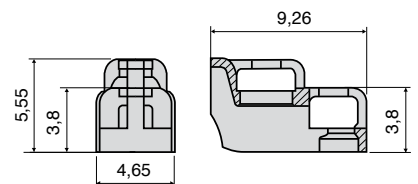
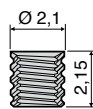
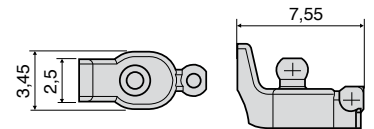
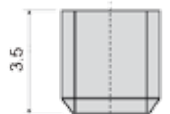
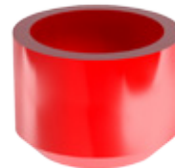
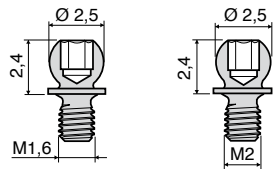
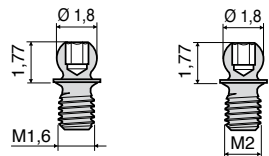
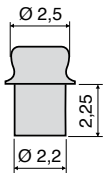
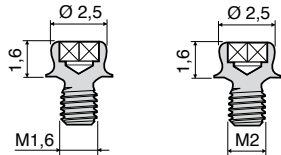
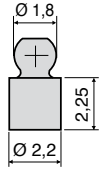
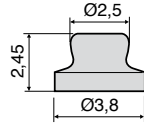
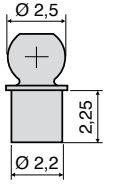
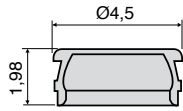



Ref.: 005SKLUS
INTRODUCTORY KIT FOR LABORATORY
 contains assorted attachments and tools



Ref.: 011SPL
S.P.L. INTRODUCTORY KIT
 contains assorted titanium BLOCK pivots, castable pivots, retentive caps and two regulating tools

ATTACHMENTS OT CAP SYSTEM

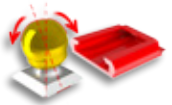

Ref.: 038STF

TITANIUM FLEX SINGLE SPHERE NORMAL SIZE + TIN
 Kit contains
 2 SINGLE TITANIUM SPHERES
 2 PINK CAPS - SOFT RETENTION
 1 SPHERE HOLDER
 2 CASTABLE SLIDING BASES

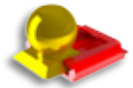

Ref.: 038STN

TITANIUM SINGLE SPHERE NORMAL SIZE + TIN
 Kit contains
 2 SINGLE TITANIUM SPHERES
 2 PINK CAPS - SOFT RETENTION
 1 SPHERE HOLDER
 2 CASTABLE SLIDING BASES



Ref.: 038STM

TITANIUM SINGLE SPHERE MICRO SIZE + TIN
 Kit contains
 2 SINGLE TITANIUM SPHERES
 2 PINK CAPS - SOFT RETENTION
 1 SPHERE HOLDER
 2 CASTABLE SLIDING BASES



Ref.: 093CTN
 NORMAL

OT CAP TECNO - NORMAL/MICRO
 Kit contains
 2 PRE-ANGULATED CASTABLE EXTENSIONS
 2 TITANIUM SINGLE THREADED SPHERES
 2 TRANSPARENT CAPS NORMAL/MICRO
 2 PINK CAPS NORMAL/MICRO
 2 YELLOW CAPS NORMAL/MICRO



Ref.: 093CTM
 MICRO



Ref.: 092CAN

OT CAP NORMAL SIZE
 Kit contains
 4 SINGLE SPHERES
 4 PINK RETENTIVE CAPS
 4 STAINLESS STEEL HOUSINGS (2 for resin - 2 for soldering)
 4 PLASTIC POSITIONING RINGS



Ref.: 092CAM

OT CAP MICRO SIZE
 Kit contains
 4 SINGLE SPHERES
 4 PINK RETENTIVE CAPS
 4 STAINLESS STEEL HOUSINGS (2 for resin - 2 for soldering)
 4 PLASTIC POSITIONING RINGS



Ref.: 196BCN

"ECONOMIC" OT CAP NORMAL SIZE
 Kit contains
 1 CASTABLE BAR
 1 CASTABLE BEVELLED BAR
 4 CLEAR RETENTIVE CAPS (Standard retention)



Ref.: 197BCM

"ECONOMIC" OT CAP MICRO SIZE
 Kit contains
 1 CASTABLE BAR
 1 CASTABLE BEVELLED BAR
 4 CLEAR RETENTIVE CAPS (Standard retention)



Ref.: 099BSN

OT CAP & MONO OT BOX FOR FRAME NORMAL SIZE
 Kit contains
 2 CASTABLE BARS (1 straight - 1 bevelled)
 4 CLEAR RETENTIVE CAPS
 4 CASTABLE MONO OT BOX
 4 PLASTIC POSITIONING RINGS



Ref.: 099BSM

OT CAP & MONO OT BOX FOR FRAME MICRO SIZE
 Kit contains
 2 CASTABLE BARS (1 straight - 1 bevelled)
 4 CLEAR RETENTIVE CAPS
 4 CASTABLE MONO OT BOX
 4 PLASTIC POSITIONING RINGS



Ref.: 058BSN

OT BOX SPECIAL NORMAL SIZE + CONNECTORS
 Kit contains
 2 OT BOX SPECIAL BARS
 4 PLASTIC POSITIONERS
 4 CONNECTORS



Ref.: 058BSM

OT BOX SPECIAL MICRO SIZE + CONNECTORS
 Kit contains
 2 OT BOX SPECIAL BARS
 4 PLASTIC POSITIONERS
 4 CONNECTORS



Ref.: 153BCN

OT BOX CLASSIC NORMAL SIZE + CONNECTORS
 Kit contains
 2 UPPER BARS
 2 LOWER BARS
 4 PLASTIC POSITIONERS
 4 CONNECTORS



Ref.: 153BCM

OT BOX CLASSIC MICRO SIZE + CONNECTORS
 Kit contains
 2 UPPER BARS
 2 LOWER BARS
 4 PLASTIC POSITIONERS
 4 CONNECTORS



Ref.: 087CRS

CONCAVE RECONSTRUCTIVE SPHERE
 Kit contains
 2 CONCAVE SPHERES IN TITANIUM - TIN COATED
 2 PINK CAPS SOFT RETENTION
 1 INSERTION TOOL
 1 GAUGE AND STRIP HOLDER
 Available in 1.8 mm, 2.2 mm, 2.5 mm diameters



Ref.: 087CRE

CONCAVE REPAIR OT EQUATOR
 Kit contains
 2 CONCAVE OT EQUATOR IN TITANIUM - TIN COATED
 2 PINK CAPS SOFT RETENTION
 1 INSERTION TOOL
 1 GAUGE AND STRIP HOLDER



Ref.: 089SRS

SOLID RECONSTRUCTIVE SPHERE
 Kit contains
 2 SOLID SPHERES IN TITANIUM - TIN COATED
 2 PINK CAPS SOFT RETENTION
 2 PROTECTIVE DISKS
 1 KEY
 Available in 1.8 mm diameter



Ref.: 064ACN
 NORMAL

ASSORTED RETENTIVE CAPS
 Kit NORMAL - Kit MICRO
 6 CLEAR CAPS - STANDARD RETENTION
 6 PINK CAPS - SOFT RETENTION
 6 YELLOW CAPS - EXTRA SOFT RETENTION
 6 GREEN CAPS - VERY ELASTIC RETENTION



Ref.: 064ACM
 MICRO

ASSORTED RETENTIVE CAPS
 Kit NORMAL - Kit MICRO
 6 CLEAR CAPS - STANDARD RETENTION
 6 PINK CAPS - SOFT RETENTION
 6 YELLOW CAPS - EXTRA SOFT RETENTION
 6 GREEN CAPS - VERY ELASTIC RETENTION

S.P.L. PIVOTS

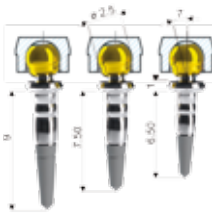

Ref.:
033PSF

PIVOT FLEX - TITANIUM PIVOT WITH SWIVEL SPHERE NORMAL SIZE (Ø 2.5 mm) FOR DIRECT OVERDENTURE
(3 Sizes available)
Kit contains
1 TITANIUM PIVOT WITH ROTATING SPHERE (adapted for COPING COVER)
1 STAINLESS STEEL HOUSING FOR RESIN
2 PINK CAPS Normal Size - Soft retention
1 ALUMINIUM DISK
3 DIRECTIONAL RINGS

Normal Sphere ø 2,5
Micro Sphere ø 1,8



Ref.:
036PTN

TITANIUM PIVOTS Normal Size Adapted for COPING COVER
Kit contains
5 TITANIUM PIVOTS Sphere 2.5 mm

Ref.:
036PTM

TITANIUM PIVOTS Micro Size Adapted for COPING COVER
Kit contains
5 TITANIUM PIVOTS Sphere 1.8 mm



Ref.:
Ref. 336PTE7
Ref. 336PTE9
Ref. 336PTE10

OT EQUATOR PIVOTS



Ref.:
010PSP

CASTABLE PIVOTS NORMAL SIZE



Ref.:
012PSM

CASTABLE PIVOTS MICRO SIZE



Ref.:
A01MOG

MOOSER BUR
Reamer for post 7 mm, 9 mm, 10 mm

Ref.:
A03MOB

MOOSER BUR
Reamer for post 12 mm, 14 mm



Ref.:
485IC

OT CAP NORMAL AND MICRO SIZE CAPS INSERTER/EXTRACTOR TOOL



Ref.:
74AC01

PARALLELOMETER MANDREL FOR OT CAP NORMAL SIZE



Ref.:
74AC02

PARALLELOMETER MANDREL FOR OT CAP MICRO SIZE



Ref.:
74AC03

PARALLELOMETER MANDREL FOR OT CAP TECNO NORMAL AND MICRO SIZE



Ref.:
080RCN

REAMER TOOL FOR CAPS OT CAP NORMAL SIZE



Ref.:
080RCM

REAMER TOOL FOR CAPS OT CAP MICRO SIZE



Ref.:
082ATN

TOOL FOR TESTING CAP RETENTION OT CAP NORMAL SIZE



Ref.:
083ATM

TOOL FOR TESTING CAP RETENTION OT CAP MICRO SIZE



Ref.:
491EC

CAPS EXTRACTOR TOOL WITH MULTIUSE HOUSING FOR CLIPS AND CAPS INSERTION

OT STRATEGY ATTACHMENTS



Ref.:
098SSS

OT STRATEGY CAPS FOR DUPLICATION TECHNIQUE
Kit contains
4 CASTABLE MALES 2 Standard + 2 High
2 CASTABLE STEADY
4 RETENTIVE CAPS



Ref.:
098CAL

OT STRATEGY CAPS FOR DUPLICATION TECHNIQUE
Kit contains
4 CASTABLE MALES (2 Standard + 2 High)
4 CASTABLE STEADY
4 STAINLESS STEEL HOUSINGS
2 POSITIONING RINGS
4 RETENTIVE CAPS



Ref.:
047ACS

OT STRATEGY ASSORTMENT CAP KIT FOR DUPLICATION TECHNIQUE
Kit contains
4 YELLOW CAPS - EXTRA SOFT RETENTION
4 PINK CAPS - SOFT RETENTION
4 CLEAR CAPS - STANDARD RETENTION



Ref.:
045ACS

OT STRATEGY ASSORTMENT CAP KIT FOR STAINLESS STEEL HOUSINGS
Kit contains
4 YELLOW CAPS - EXTRA SOFT RETENTION
4 PINK CAPS - SOFT RETENTION
4 CLEAR CAPS - STANDARD RETENTION



Ref.:
486ICS

OT STRATEGY CAPS INSERTER/EXTRACTOR TOOL



Ref.:
75AC04

PARALLELOMETER MANDREL FOR OT STRATEGY



Ref.:
081RCS

REAMER TOOL FOR OT STRATEGY CAPS

OT BAR MULTIUSE ATTACHMENTS



Ref.:
021OBM

OT BAR MULTIUSE
Kit contains
2 BARS
4 POSITIONING CLIPS A
4 POSITIONING CLIPS B
4 BOXES
4 RETENTIVE PINK CLIPS
4 RETENTIVE YELLOW CLIPS
2 CONNECTORS
1 GINGIVAL CONNECTOR



Ref.:
429IOBM

OT BAR CLIPS INSERTER/EXTRACTOR TOOL



Ref.:
028OCP

PARALLELOMETER MANDREL FOR OT BAR MULTIUSE

OT VERTICAL ATTACHMENTS



Ref.:
071OBV

OT VERTICAL
Kit contains
4 CASTABLE MALES
4 CASTABLE STEADY
4 RETENTIVE WHITE CLIPS
2 RETENTIVE GREEN CLIPS
4 CASTABLE PARALLELOMETER KEYS + PIN



Ref.:
472ICV

OT VERTICAL CLIPS INSERTER/EXTRACTOR TOOL

OT EQUATOR



OT EQUATOR CASTABLE



Ref.:
092ECQ

OT EQUATOR CASTABLE

- Kit Contains:
- 2 CASTABLE MALES
 - 2 TITANIUM HOUSINGS
 - 4 RETENTIVE CAPS

OT EQUATOR FOR IMPLANTS



Ref.:
130

OT EQUATOR FOR IMPLANTS

- Kit Contains:
- 1 OT EQUATOR
 - 1 TITANIUM HOUSING
 - 1 PROTECTIVE DISK
 - 4 RETENTIVE CAPS



Ref.:
030

- 1 OT EQUATOR ABUTMENT
*Compatible with ALL implant systems



Ref.:
335SBC

OT EQUATOR SMARTBOX KIT
self-aligning caps housing

- Kit Contains:
- 1 SMARTBOX HOUSING WITH BLACK CAP FOR LABORATORY
 - 1 PINK PROTECTIVE DISK
 - 4 RETENTIVE CAPS
(1 EXTRA-SOFT, 1 SOFT, 1 STANDARD, 1 STRONG)



Ref.:
330SBE

- Kit Contains:
- 1 SMARTBOX HOUSING WITH BLACK CAP FOR LABORATORY

OT EQUATOR BAR



Ref.:
160EQB

OT EQUATOR WITH
THREADED SLEEVE
For Bonding

- Kit Contains:
- 2 THREADED OT EQUATOR-1.6 mm thread
 - 2 THREADED SLEEVES-1.6 mm thread
 - 2 STAINLESS STEEL HOUSINGS
 - 2 WAXING SPACERS
 - 8 RETENTIVE CAPS
2 YELLOW - EXTRA SOFT
2 PINK - SOFT
2 CLEAR - STANDARD
2 BLACK - PROCESSING



Ref.:
039SFE2

- 1 THREADED OT EQUATOR
2 mm universal thread

OT EQUATOR ELASTIC SEEGER



Ref.:
158ESA

Passive Bar Connection

ELASTIC SEEGER

- Kit Contains:
- 1 CASTABLE CYLINDER HOUSINGS FOR SEEGER
 - 1 SELF-EXTRACTING SEEGER
 - 1 TITANIUM LOCKING SCREW FOR SELF-EXTRACTING SEEGER

TOOLS



Ref.:
74AC01

- PARALLELOMETER MANDREL NORMAL



Ref.:
774CHE

- OT EQUATOR SQUARE DRIVER 1.25 mm + HOLDER



Ref.:
760CE

- OT EQUATOR HANDPIECE CONNECTOR 1.25 mm



Ref.:
085SIS

- STEEL INSERTION TOOL FOR SEEGER



Ref.:
491EC

- CAPS EXTRACTOR TOOL WITH UNIVERSAL INSERTER HOUSING

ACCESSORIES



Ref.:
044CAIN

- 2 IMPRESSION TRANSFER (pick up impression)



Ref.:
144MTE

- 2 IMPRESSION TRANSFER



Ref.:
144AE

- 2 STAINLESS STEEL ANALOGS For OT Equator



Ref.:
485IC

- CAPS INSERTER/EXTRACTOR TOOL (OT EQUATOR-NORMO-MICRO)

SPARE PARTS



Ref.:
192ECE

OT EQUATOR CAP ASSORTMENT KIT

- Kit Contains:
- 1 STAINLESS STEEL HOUSING
 - 1 BLACK CAP - PROCESSING
 - 4 RETENTIVE CAPS:
1 YELLOW - EXTRA SOFT - 1 PINK - SOFT
1 CLEAR - STANDARD - 1 VIOLET - RIGID
 - 1 BLACK - PROCESSING - 1 PROTECTIVE DISK

OT CAP / OT EQUATOR IMPRESSION COPINGS



- ▶ Ref.: 044CAIN • 2 STAINLESS STEEL IMPRESSION COPINGS For OT CAP Normal and OT EQUATOR
- ▶ Ref.: 044CAI22 • 2 STAINLESS STEEL IMPRESSION COPINGS Ø 2.25mm Spheres with interchangeable cap
- ▶ Ref.: 044CAIM • 2 STAINLESS STEEL IMPRESSION COPINGS For OT CAP Micro

TOOLS



- ▶ Ref.: 772CSF • HEX DRIVER - 0.9 mm For Threaded Micro Sphere

SINGLE THREADED SPHERES WITH THREADED BONDING SLEEVE



- Titanium + TiN Threaded Sphere With Sleeve For Bonding Kit - NORMAL SIZE**
- Ref.: 139KSFN
- Kit contains:
- 2 TITANIUM SINGLE THREADED SPHERES 1.3 mm Hex, 1.6 mm Thread
 - 2 TITANIUM THREADED SLEEVES For Bonding
 - 2 WAXING SPACERS For Threaded Sphere - Normal Size



- Titanium + TiN Threaded Sphere With Sleeve For Bonding Kit - MICRO SIZE**
- Ref.: 139KSFM
- Kit contains:
- 2 TITANIUM SINGLE THREADED SPHERES 0.9 mm Hex, 1.6 mm Thread
 - 2 TITANIUM THREADED SLEEVES For Bonding
 - 2 WAXING SPACERS For Threaded Sphere - Micro Size

SINGLE THREADED SPHERES

NORMAL - MICRO



- ▶ Ref.: 039SFN2 • 1 TITANIUM + TiN THREADED SPHERE NORMAL 1.3 mm Hex, 2.0 mm Thread



- ▶ Ref.: 039SFM2 • 1 TITANIUM + TiN THREADED SPHERE MICRO 0.9 mm Hex, 2.0 mm Thread

OT LOCK



- OT LOCK KIT
- Ref.: 880CLT
- Kit contains:
- 1 COMPLETE OT LOCK
 - 1 BRASS POSITIONER
 - 1 CERAMIC PIN



- ADJUSTABLE OT LOCK KIT
- Ref.: 880CLR
- Kit contains:
- 1 COMPLETE ADJUSTABLE OT LOCK
 - 1 EXTENDED BRASS POSITIONER
 - 1 CERAMIC PIN
 - 9 CASTABLE SPACER RINGS

OT LOCK SPARE PARTS



- ▶ Ref.: 882CG • CONICAL GUIDE



- ▶ Ref.: 882CAS • UNLOCKING TOOL

INCLUDES OT CAP & OT BOX - OT STRATEGY - OT BAR - OT VERTICAL - OT UNILATERAL - OT EQUATOR

"BASIC" PROMOTIONAL KIT FOR LABORATORY



- Ref.: 005SKLBUS

TOOLS:

- 1 TWEEZER
- 1 PARALLELOMETER MANDREL OT CAP NORMO
- 1 PARALLELOMETER MANDREL OT CAP MICRO
- 1 PARALLELOMETER MANDREL OT STRATEGY
- 1 PARALLELOMETER MANDREL OT BAR MULTIUSE
- 1 BLUE PLASTIC UNIVERSAL INSERTION HANDLE
- 1 INSERTION TOOL - OT CAP NORMAL / MICRO
- 1 INSERTION TOOL - OT STRATEGY
- 1 INSERTION TOOL - OT BAR MULTIUSE
- 1 INSERTION TOOL - OT VERTICAL

Kit contains:

OT CAP - OT BOX:

- 16 ASSORTED CASTABLE PIVOTS NORMAL / MICRO
- 4 CASTABLE SPHERES NORMAL / MICRO
- 2 CASTABLE OT CAP BARS NORMAL / MICRO
- 2 CASTABLE OT BOX BARS CLASSIC (top + bottom) NORMAL / MICRO
- 1 CASTABLE OT BOX SPECIAL BARS NORMAL / MICRO
- 6 CASTABLE OT BOX CONNECTORS
- 4 CASTABLE OT BOX MONO HOUSING NORMAL / MICRO
- 8 POSITIONER RINGS NORMAL / MICRO
- 28 OT CAP RETENTIVE CAPS NORMAL / MICRO YELLOW, PINK, CLEAR, GREEN
- 9 BLACK CAPS - FOR PROCESSING NORMAL / MICRO
- 4 STAINLESS STEEL HOUSINGS NORMAL / MICRO FOR RESIN

OT STRATEGY:

- 4 OT STRATEGY MALES - 2 STANDARD BASE - 2 LONG BASE
- 2 CASTABLE STEADY

- 6 OT STRATEGY CAPS FOR STAINLESS STEEL HOUSING YELLOW, PINK, CLEAR

OT STRATEGY CONTINUED:

- 2 OT STRATEGY STAINLESS STEEL HOUSINGS
- 2 OT STRATEGY PLASTIC POSITIONING RINGS
- 6 OT STRATEGY CAPS FOR DUPLICATION TECHNIQUE YELLOW, PINK, CLEAR
- 4 BLACK CAPS - PROCESSING (for wax and for duplication technique)

OT EQUATOR:

- 2 CASTABLE MALES
- 2 STAINLESS STEEL HOUSINGS
- 4 RETENTIVE CAPS - 2 PINK, 2 CLEAR
- 2 BLACK CAPS FOR LABORATORY USE

OT UNILATERAL:

- 1 CASTABLE ATTACHMENT WITH COMBINED SPHERES
- 1 CASTABLE UNI-BOX
- 1 MICRO POSITIONING RING
- 2 OT CAP MICRO CAPS - 1 PINK, 1 BLACK

- 2 OT STRATEGY CAPS - 1 PINK, 1 BLACK For Duplication Technique
- 1 CONNECTOR

OT BAR MULTIUSE:

- 1 CASTABLE BARS
- 1 BAR EXTENSION
- 4 POSITIONING CLIPS (Type A - Type B)
- 2 CASTABLE BOXES
- 4 CLIPS - 2 PINK, 2 YELLOW

OT VERTICAL:

- 2 CASTABLE MALES
- 2 CASTABLE STEADY
- 4 CLIPS - 2 WHITE, 2 GREEN
- 2 PARALLELOMETER KEYS + PIN
- 2 CERAMIC PINS

IMPLANTOLOGY

SPHERO FLEX - BLOCK SYSTEM TITANIUM ATTACHMENTS FOR OVERDENTURES



- SPHERO FLEX**
- 1 Titanium Abutment with self-aligning 2.5mm sphere
 - 2 Pink Caps - Soft Retention
 - 1 Stainless Steel Housing
 - 1 Protective Disk
 - 3 Directional Rings
- Ref.: 109

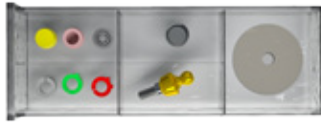

- SPHERO BLOCK NORMAL**
- 1 Titanium Abutment with stationary 2.5mm sphere
 - 2 Pink Caps - Soft Retention
 - 1 Stainless Steel Housing
 - 1 Protective Disk
 - 3 Directional Rings
- Ref.: 002

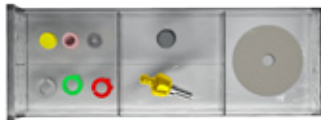

- SPHERO BLOCK MICRO**
- 1 Titanium Abutment with stationary 1.8mm sphere
 - 2 Pink Caps - Soft Retention
 - 1 Stainless Steel Housing
 - 1 Protective Disk
 - 3 Directional Rings
- Ref.: 003

ANCILLARY ITEMS

14 cm height



- Ref.: 00PB
MINI PARALLELOMETER
WITH UNIVERSAL TILTING MODEL TABLE
(FOR LABORATORY USE, COURSES, ETC.)



- Ref.: OC
OT CEM is a self and photo curing cement. It is designed for permanent metal to metal bonding in the use of attachments in prosthetic implant solutions.

SPHERO FLEX / SPHERO BLOCK TOOLS



- Ref.: 771CEF
UNIVERSAL KEY FOR SPHERO FLEX AND SPHERO BLOCK - NORMAL / MICRO
Hex 2.3 mm



- Ref.: 760CBM
HEX DRIVER
FOR CONTRA-ANGLE TORQUE CONTROLLER



- Ref.: 760CBR
SCREW DRIVER FOR OT REVERSE THREADED SPHERE NORMAL
Hex 1.3 mm

SPECIALTY ITEMS FOR IMPLANTS



- Ref.: 008MBG
CUFF HEIGHT MEASURING TOOL
Kit contains:
- 1 CUFF HEIGHT SLIDER GAGUE
 - 1 CUFF HEIGHT FIXED ROD GAGUE
 - 1 SILICON RINGS DISPENSER
 - 20 SILICON RINGS



- Ref.: 680
BROKEN SCREW EXTRACTOR KIT
For removing broken screws from implants

- Kit contains:
- 1 MANUAL CENTERING DEVICE
 - 1 POSITIONER
 - 1 CLAW REAMER BUR
 - 1 REVERSE CUTTING BUR
- Kit contains:
- 1 CLAW REAMER BUR
 - 1 REVERSE CUTTING BUR

- Ref.: 680FS 1 REVERSE CUTTING BUR
Ref.: 680FL 1 FCLAW REAMER BUR

IMPLANTOLOGY

ACCESSORIES FOR IMPLANTS

For information on abutments for other implant systems please contact Rhein83

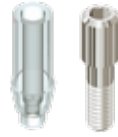

- Ref.: 108CV
Screw Vent Castable Abutment
Non-Rotating with titanium screw
White - Precision Hex
3.5 mm diameter

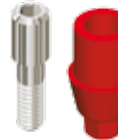

- Ref.: 108AVB
Screw Vent Castable Abutment
Non-Rotating with titanium screw
Red - Conical Hex For Bar Connections
3.5 mm diameter



- Ref.: 108BRK
Branemark Castable Abutment
Rotating with titanium screw
3.75 mm - 4.0 mm diameter



- Ref.: 108BRK-NR
Branemark Castable Abutment
Non-Rotating with titanium screw
3.75 mm - 4.0 mm diameter

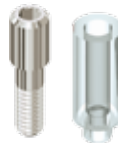

- Ref.: 108PE
Pitt Easy Castable Abutment
Non-Rotating with titanium screw
3.25 mm - 3.75 mm - 4.0 mm diameter

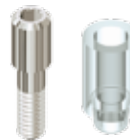

- Ref.: 108BFT
Straumann ITI Castable Abutment - Rotating
with titanium screw for bar connections



- Ref.: 113BFT
Steel Transfer Abutment For Straumann ITI Implant
with titanium screw



- Ref.: FA004
Steel Analog For Straumann ITI Implant

Rhein83 manufactures castable abutments and titanium screws for most implant systems. For implant systems that are not listed in this catalog, please contact Rhein83 for additional information.



A GLOBAL VISION WITH A COMMON TARGET

Our mission is to offer to the professionals of the dental field, different quality solutions allowing to reach the patient's comfort and satisfaction regardless the different social and financial situations. This is possible to the precious support of our partners worldwide!

466 Main Street - Lower Level • New Rochelle, NY 10801 • Toll Free 877-778-8383 • Tel. 914-235-0096 • Fax 914-633-6363



Rhein83 USA branch is active in the area since the year 2000 by supporting the distribution in the entire country including different areas in Latin America. Rhein83 USA is located in New Rochelle (few minutes away from NYC), taking care of developing an intense program of formation with courses dedicated to dentists and dental technicians. Courses will allow the attendants to have CTD's credits with speakers members of the "National Board for Certification in Dental Laboratory Technology, Inc":



The unique feature of the dental world consists in different techniques, knowledges and procedures used by the dental specialists. This is the reason why Rhein83 receives and publish every day clinical cases from over 100 world countries! Share your talent, and passion with us and learn new interesting working protocols by the best experts!



Rhein Attachments



rhein83_attachments



Rhein Attachments



@RheinDental



rhein83 ita

Rhein83 is proud to be partner in the scientific research leading to the publication of the first international book dedicated to combined prosthesis. 27 authors involved (dentists and dental technicians) presenting interesting clinical cases with innovative overdenture solutions. Professors from 3 different dentistry Universities involved in writing the book: Università Vita-Salute San Raffaele di Milano University, Torino Dental School University, Siena Dentistry University.

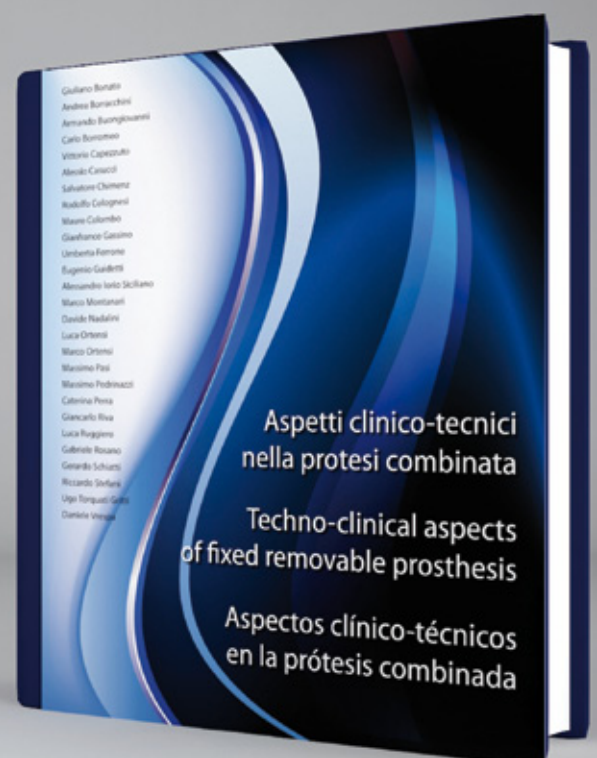



The unique feature of the dental world consists in different techniques, knowledges and procedures used by the dental specialists. This is the reason why Rhein83 receives and publish every day clinical cases from over 100 world countries! Share your talent, and passion with us and learn new interesting working protocols by the best experts!



Rhein Attachments



rhein83_attachments



Rhein Attachments



@RheinDental



rhein83 ita

Rhein83 is proud to be partner in the scientific research leading to the publication of the first international book dedicated to combined prosthesis. 27 authors involved (dentists and dental technicians) presenting interesting clinical cases with innovative overdenture solutions. Professors from 3 different dentistry Universities involved in writing the book: Università Vita-Salute San Raffaele di Milano University, Torino Dental School University, Siena Dentistry University.

